

Thank you for choosing

Panasonic Omnivision **VHS**

MODEL PV-4617

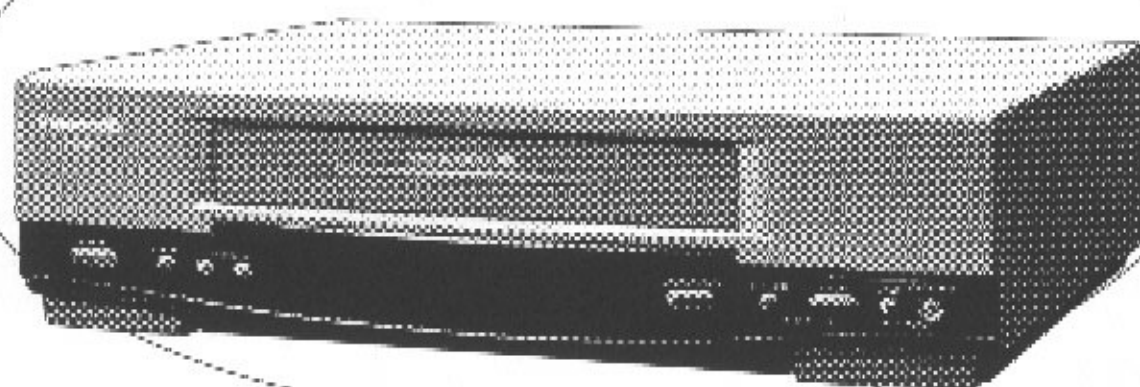

Video Cassette Recorder

VCR *plus+*

Operating Instructions

Please read these instructions carefully before attempting to connect, operate or adjust this product and save this manual.
Spanish Quick Use Guide is included.
Guía para rápida consulta en español está incluido.

P6 ~ P9
Connections

P10 ~ P13
Getting Started

P14 ~ P17
Basic Operation

P18 ~ P26
More You Can Do

P27 ~ Back Cover
Other Information

Things You Should Know

Congratulations

on your purchase of one of the most sophisticated and reliable products on the market today. Used properly, we're sure it will bring you and your family years of enjoyment. Please take time to fill in the information at right. The serial number is on the tag located on the back of your VCR. You'll want to keep this manual handy as your convenient VCR information source.

Date of Purchase _____
Dealer Purchased From _____
Dealer Address _____
Dealer Phone No. _____
Model No. **PV-4617** _____
Serial No. _____

Safety Precautions

Warning: To prevent fire or shock hazard, do not expose this equipment to rain or moisture. This video recorder, equipped with the HQ (High Quality) System, is compatible with existing VHS equipment.

Only use those tapes with the **VHS** mark. It is recommended that only cassette tapes that have been tested and inspected for use in 2, 4, 6, and 8 hour VCR machines be used.

FCC Warning: Any unauthorized changes or modifications to this equipment would void the user's authority to operate.

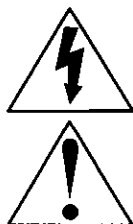
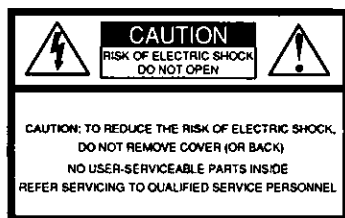

This symbol warns the user that uninsulated voltage within the unit may have sufficient magnitude to cause electric shock. Therefore, it is dangerous to make any kind of contact with any inside part of this unit.

This symbol alerts the user that important literature concerning the operation and maintenance of this unit has been included. Therefore, it should be read carefully in order to avoid any problems.

Table of Contents

Important Safeguards and Precautions	3
Unpacking Your VCR and Features	4
VCR and Cassette Information (Record Tab, Tape Speeds, Tape Cleaning, Specifications)	5

Connections

Basic Connection (Antenna and VCR, VCR and TV)	6, 7
Additional Connections (CATV, Audio/Video)	8, 9

Getting Started

One Time VCR Setup (On-screen Language, Channel Memory, Auto Clock Set)	10, 11, 12
On Screen Displays (OSD) (Function, Channel, Menu, VCR Status & Clock, Warning, Instruction)	13

Basic Operation

Playback a Tape (Main Operation, Special Effects, Quality Picture Features)	14
Tape Operation (Repeat Play, One Minute Skip, Zero Search, Auto Functions)	15
Record On a Tape (Main Operation, One Touch Record, Channel Selection, Select Input Mode)	16, 17

More You Can Do

Timer Recording (Main Operation, Cancel-Clear or Replace, Program Contents)	18, 19
Timer Recording Using VCR Buttons	20
Copying Your Tapes (Dubbing) (Connection, Main Operation, Monitoring)	21
VCR Plus+ Set Up (Cable Box Set Up, VCR Plus+ Channel Set Up)	22, 23
VCR Plus+ Programming (Main Operation, Make Corrections)	24
Special VCR Features (VCR Lock, Warning Beeper)	25
Multi-Brand Control Feature	26

Other Information

Before Requesting Service (Self-check items)	27
Spanish Quick Use Guide/Guía para rápida consulta	28, 29, 30
Index of Controls (Remote Control, VCR)	31, Back Cover

Important Safeguards and Precautions

INTRODUCTION

Careful attention has been given to this Video product to assure a quality standard devoted to your safety and enjoyment. This quality standard together with your personal responsibility for the safety of yourself and others, will contribute to your enjoyment. This Video product uses electrical energy and requires proper handling at all times.

CAUTION

READ AND RETAIN THE SAFETY AND OPERATING INSTRUCTIONS To make full use of the safeguards incorporated in this unit, read and follow this basic guide, adopted in part from Underwriter's Laboratories Standard 1409, Second Edition, before operating this Video product.
FOLLOW THE INSTRUCTIONS AND BE SURE TO HEED ALL WARNINGS on unit and in the manual, for easy maintenance, proper and trouble free operation of this Video product.

INSTALLATION

- OPERATE FROM A POWER SOURCE INDICATED** on this Video product, or in this Manual. Your Electric Utility Service Company or Video Products Dealer will be happy to verify the power source in your home.
- THE GROUNDED OR POLARIZED PLUG IS A SAFETY FEATURE** This Video product may be equipped with either a polarized 2-wire AC line plug or a 3-wire grounding type plug. The two wire polarized plug (having one blade wider than the other) will fit into the power outlet only one way. If it is a three wire grounding type plug (having a third pin), it will fit into a grounding type outlet.
DO NOT DEFEAT THE SAFETY PURPOSE OF THE GROUNDED OR POLARIZED PLUG by tampering with it. If the plug does not fit fully into the socket, try reversing it. If you should still be unable to fully insert the plug into the socket, you may find that a proper outlet is needed to meet today's Electrical Standards. An electrician will replace your outlet safely.
- POWER SUPPLY CORDS SHOULD BE PROTECTED** and routed so that they are not likely to have anything rest on them, roll over them, or be subject to walking traffic or abuse: particularly at plug-ins, convenience receptacles, or cord exit points from the unit. Where an extension is needed, use a grounded or polarized cord.
HAZARDOUS FRAYED CORDS OR DAMAGED PLUGS SHOULD BE REPLACED BY A QUALIFIED SERVICE TECHNICIAN.
OVERLOADED WALL OUTLETS AND EXTENSION CORDS PRESENT DANGEROUS RISKS OF FIRE OR ELECTRICAL SHOCK.
- AVOID BLOCKING VENTILATION HOLES**
Your video unit has ventilation openings in its cabinet to release heat generated during operation. Blocking these opening can cause heat build-up inside the unit, causing failure that may result in a fire hazard or heat damage to cassettes. For protection:
 - Never cover the bottom ventilation slots or the unit with soft material, or operate the unit placed on a bed, sofa, rug, or soft accessory.
 - Avoid built-in installations, such as a bookcase or rack, unless proper ventilation is provided.
- AVOID EXTREMELY HOT LOCATIONS OR SUDDEN CHANGES IN TEMPERATURE** such as placing the unit near or over a radiator, in direct sunlight, closed vehicles, or transporting it suddenly between areas of extreme temperature variation.
If the unit is suddenly moved from a cold place to a warm place, moisture may form on the tape and inside the unit.
- TO AVOID INJURY TO A CHILD, ADULT; OR COSTLY DAMAGE:**
 - Do not place unsecured equipment on a sloping surface or any heavy object or unit.
(Use the unit in a horizontal position and do not place anything heavy on it.)
 - Support for the unit should be adequately firm, level, and strong. Replace any unstable cart, table or support. An appliance and cart combination should be moved with care. Quick stops, excessive force, and uneven surfaces may cause the appliance and cart combination to overturn.
 - Carefully follow all operating instructions and use the manufacturer's recommended accessories when operating this unit or connecting it to any other equipment.



OUTSIDE ANTENNA, EQUIPMENT, AND POWERLINE EXPOSURE

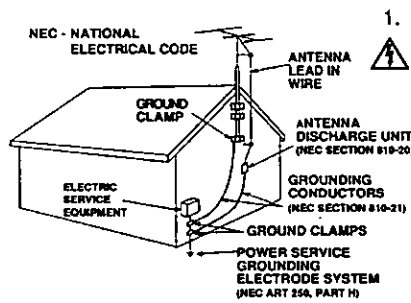

- INSURE SAFE ANTENNA AND CABLE CONNECTIONS**
If an outside antenna or cable system is connected to the equipment, be sure the antenna or cable system is grounded so as to provide some protection against built up static charges and voltage surges. Part 1 of the Canadian Electrical Code, in USA Section 810 of the National Electrical Code, ANSI/NFPA 70, provides information with respect to proper grounding of the mast and supporting structure, grounding of the lead-in wire to an antenna discharge unit, size of grounding conductors, location of antenna discharge unit, connection to grounding electrodes and requirements for the grounding electrode.
- ELIMINATE ANTENNA PROXIMITY TO HIGH VOLTAGE POWER SOURCES, OR CHANCE OF ACCIDENTAL CONTACT BY INSTALLER**
An outside antenna system should be located where it will never be reached by power lines, electric light or power circuits and where it will never contact these power sources if it falls. Installer should use extreme care to avoid possible fatal contact by touching power lines, circuits or other power sources when installing an outside antenna.

USE

- AFTER STORING OR WHEN MOVING THE UNIT, REFER TO THE INSTALLATION SECTION OF THE SAFEGUARDS.**
- DO NOT USE THIS VIDEO UNIT NEAR WATER:** around bathtubs, sinks, laundry, wet basement, swimming pool or any water source.
 - USE ACCESSORIES RECOMMENDED ONLY BY THE MANUFACTURER** to avoid risk of fire, shock or other hazards.
 - UNPLUG ALL EQUIPMENT EXPOSED TO RAIN, MOISTURE, OR STRONG IMPACT AND GET A QUALIFIED INSPECTION**
If your unit has been exposed to rain, water, excessive moisture, or subjected to strong impact, unplug it and have it inspected by a service technician before use.
 - UNPLUG UNUSED UNIT, AND ALL EQUIPMENT DURING A STORM**
During a lightning storm, when indoors or outdoors, or before leaving unit unused for extended periods of time, disconnect all equipment from power source, antenna and cable system.
 - UNPLUG ALL EQUIPMENT BEFORE CLEANING.** After unit has been unplugged use a dry, clean, chemically untreated cloth. Use no cleaning fluids, aerosols, or forced air that could over-spray, or soak into the unit, and cause electrical shock. Any substance such as wax, adhesive tape, etc. may affect the cabinet surface. Exposure to greasy, humid, or dusty areas may affect internal parts.
 - WHEN PLUGGED-IN: KEEP WATER AWAY; NO FINGERS INSIDE NOR ANY OBJECTS INSIDE; AND NO MAGNETS OR ELECTRICAL INTERFERENCE NEARBY.**
 - Never operate the unit if liquid has been spilled into it. Immediately unplug the unit, and have it inspected by a service technician. Fire and shock hazards can result from electrical shorts caused by liquid contact inside.
 - Caution the children about dropping or pushing objects into the unit. Some parts inside carry hazardous voltages and contact can cause electric shock. Objects dropped in electrical equipment can cause fire hazards.
 - Separate the unit from any interference causing appliances. Placing the unit directly above or below your TV set may cause electrical interference. Keep all magnets away from electronic equipment.

SERVICE

- DO NOT ATTEMPT TO SERVICE THIS PRODUCT YOURSELF.** If this Video product does not operate as described, when the detailed Operating Instructions are followed, do not attempt to open or remove covers, or make any adjustments not described in the manual. Attempting to service this unit yourself may expose you to dangerous voltage or other hazards. Refer all servicing to qualified service personnel.
- CHECK ON REPLACEMENT PARTS REQUIRED.** Be sure the service technician has used replacement parts specified by the manufacturer or having the same characteristics as the original part. Unauthorized substitutes may result in fire, electric shock or other hazards.
- HAVE TECHNICIAN PERFORM SAFETY CHECK** described in the manufacturer's service literature, after any service or repairs, to determine that the Video unit is in safe operating order.

Unpacking Your VCR and Features

Unpacking Your VCR

The accessories shown below are provided to help you use or set up your VCR. Optional accessories are also listed.

Accessories

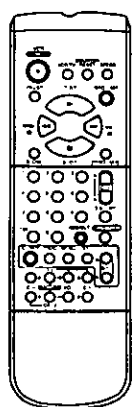

Remote Control
VSQS1479

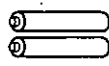

2 "AA"
Batteries



RF Coaxial
Cable
VJAS0183

Optional Accessories

- 1/2" Video Cassette Tape

Load the batteries in the Remote Control

1 Lift off the lid after pressing in and up on the latch with your thumb nail or other narrow object.

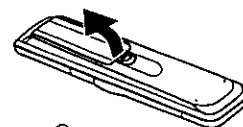

2 Install two batteries as indicated inside the Battery Compartment.

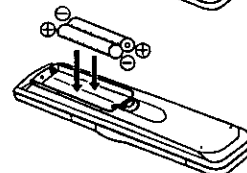

3 Fit the lid's hinge piece into the indent on the case, and snap lid into place.

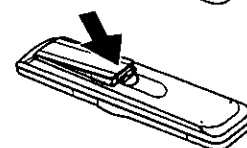

Battery replacement caution

- Do not mix old and new batteries. (Also, never mix alkaline with manganese batteries.)

Product Features

All Channel Auto Set/ 181-CH TV/CATV Tuner	10
Auto Clock Set	10, 11
Auto Daylight Saving Time	5
Auto Operation Functions (Auto Playback, Rewind, Tape Eject, Power off)	15
Auto Repeat Function	15
Digital Auto Picture	14
Easy-to-Read English/Spanish/French On Screen Displays	10, 11, 12, 18, 19
Multi Brand TV/Cable Box Remote Control	26
One Minute Skip	15
One Month, 8 Program Timer Recording	18, 19
One Touch Recording (OTR)	16
Quick Play Mechanism	27
Special Effects Playback	14
Special VCR Features (VCR Lock, Warning Beeper)	25
VCR Plus+ Recording	22, 23, 24
Zero Search	15

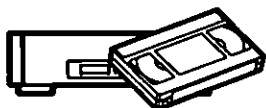

VCR and Cassette Information

Erase Protection (Record Tab)

Cassettes have a record tab to ensure that recordings are not accidentally erased.

To prevent accidental erasure, break off the tab with a screwdriver.



To record again, cover the hole with cellophane tape.



Maximum Record/Playback Time

Only use tapes with the **VHS** mark in this unit.

Tape Speed Position	Type of Video Cassette		
	T60	T120	T160
SP (Standard Play)	1 Hour	2 Hours	2 Hours 40 Minutes
LP (Long Play)	2 Hours	4 Hours	5 Hours 20 Minutes
SLP (Super Long Play)	3 Hours	6 Hours	8 Hours

Cleaning Care for Video Heads



Clogged Video Head Picture

or

Blue Back
(During playback of pre-recorded tape)

Blue Back Screen

Clogged Video Heads

While your VCR will not normally require head cleaning, however the heads may become clogged when playing an old or damaged tape. If the image on your screen resembles the illustration on the left or the screen becomes solid blue when playing back a pre-recorded signal on the tape, the heads probably require cleaning.

Cleaning the Heads

It is recommended that head cleaning be performed by a qualified service technician. Please contact your nearest Panasonic Service Center. An alternate solution is to obtain a head cleaning cassette. Be sure to follow the cleaning instructions carefully. Excessive use of a cleaning cassette could shorten head life. Use this cassette only when symptoms occur.

Reset all VCR Memory Functions

This operation is convenient when moving the VCR to a new location, or if a mistake was made in the One Time VCR Setup section. Make sure a tape is not inserted in the VCR.

- 1) Turn VCR Power on.
- 2) Press and hold both Play and Rewind buttons on the VCR for more than 5 seconds.
 - The power will shut off.
- 3) Perform the One Time VCR Setup section on page 10.

D.S.T. (Daylight Saving Time)

Spring:

First Sunday in April (DAYLIGHT SAVING TIME:AUTO) Automatically adds one hour and adjusts the clock.

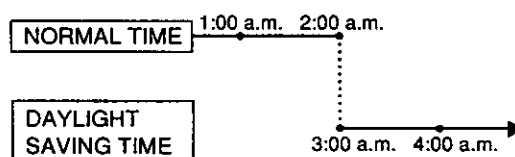

Autumn:

Last Sunday in October (DAYLIGHT SAVING TIME: AUTO) Automatically turns back one hour and adjusts the clock.

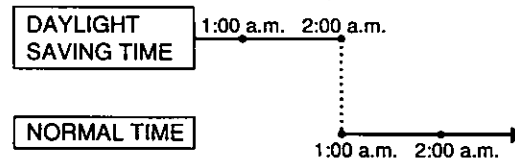

Product Specifications

Power Source:	120V AC, 60 Hz
Power Consumption:	Approx. 18 watts (Power On) Approx. 6 watts (Power Off)
Video Signal:	EIA Standard NTSC color
Video Recording System:	4 rotary heads helical scanning system
Audio Track:	1 track (Normal)
Tuner:	
Broadcast Channels:	VHF 2~13, UHF 14~69
CATV Channels:	Midband A through I (14~22) Superband J through W (23~36) Hyperband AA~EEE (37~64) Lowband A-5~A-1 (95~99) Special CATV channel 5A (01) Ultraband 65~94, 100~125
Operating Temperature:	41°F~104°F (5°C~40°C)
Operating Humidity:	10%~75%
Weight:	7.9 lbs. (3.6 Kg)
Dimensions:	14-3/16" (W) X 3-1/2" (H) X 11-1/4" (D) 360 (W) X 89 (H) X 285 (D) mm

Note: Designs and specifications are subject to change without notice.



Basic Connection

ANTENNA

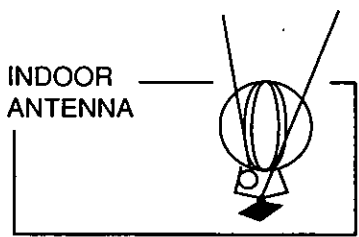

INDOOR ANTENNA

or

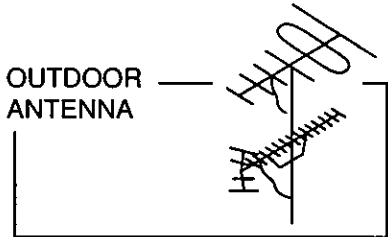

OUTDOOR ANTENNA

or

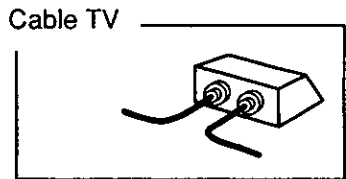

Cable TV

Disconnect the antenna or cable from your TV and connect it to the VCR (IN FROM ANT.)

VCR

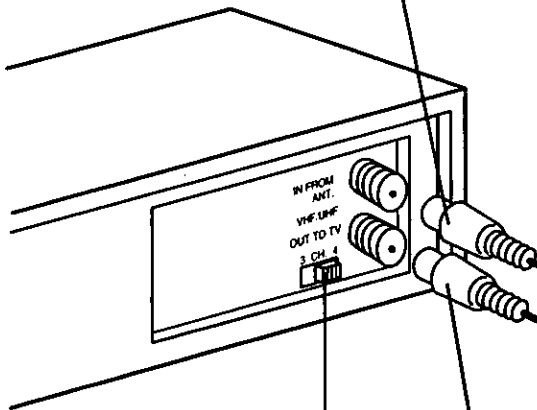

Set the Output Channel of your VCR to channel 3 or 4 (whichever is not being transmitted on by a Local TV broadcast).

Antenna Cable

TV

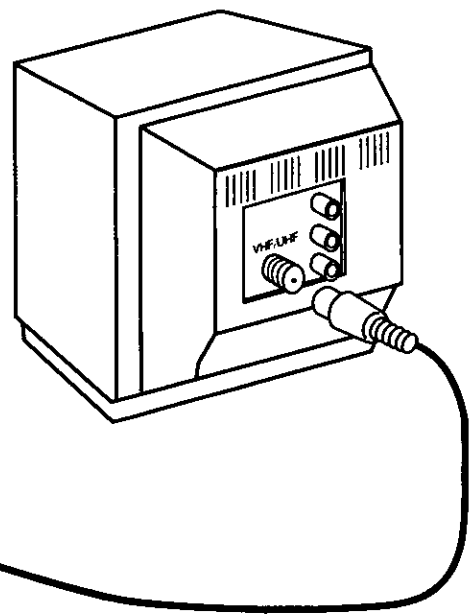

RF Coaxial Cable (VCR-TV Connection Cable) (supplied)

Connect the VCR to your TV with the RF Coaxial Cable (OUT TO TV).

Between Antenna and VCR

Case 1: Twin Lead Cable Only

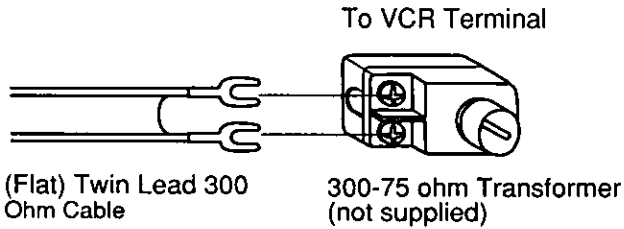

Case 2: Twin Lead & Coaxial Cables

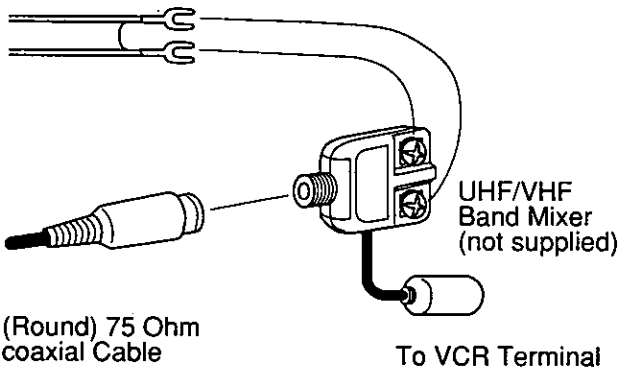

Case 3: Two Twin Lead Cables

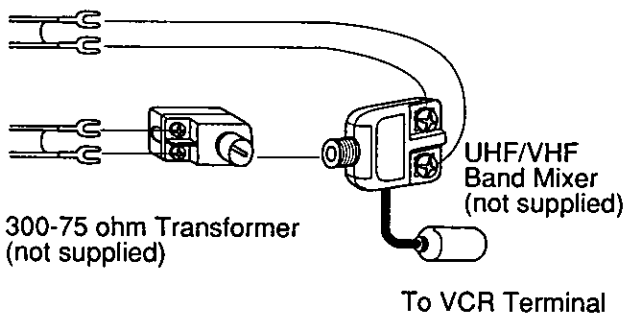

- If your TV has both post and screw-type VHF terminals, using the post connection is recommended to minimize signal loss.

Between VCR and TV

Case 1: Screw & Plug Type Terminal

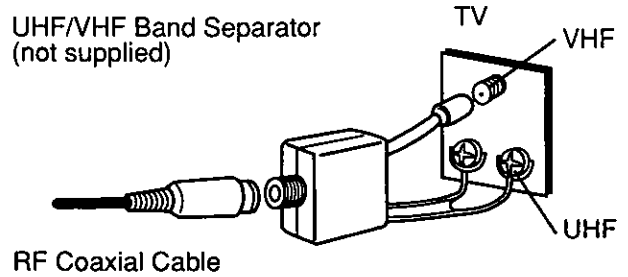

Case 2: Screw Type Terminal

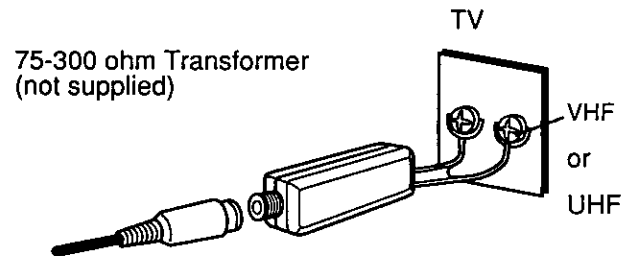

Case 3: Double Screw Type Terminal

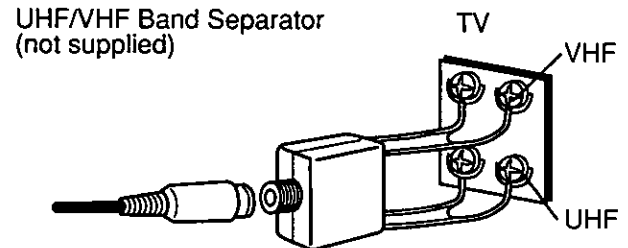

Case 4: Complex TV Terminal

TERMINALS ON BACK OF TV SET

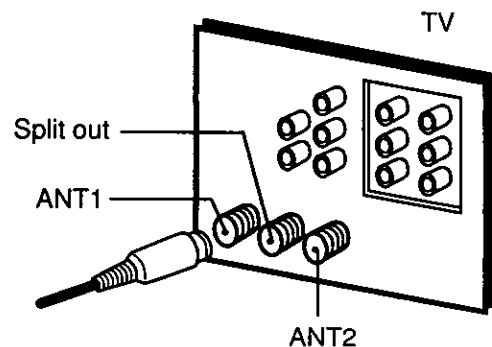

- Connect to one of the ANT terminals and select the same antenna number on the TV.



Additional Connections

CATV(Cable) Connections

All connections on this page are made with 75 Ohm coaxial cables.

Without a Converter/Descrambler Box

You can:

- 1) Use your VCR Remote Control to select channels.
- 2) Program one or more unscrambled channels for unattended recording.

NOTE: You cannot record or view scrambled channels with this connection.

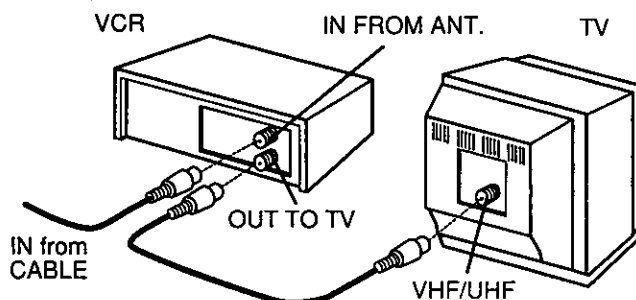

With a (CABLE to VCR) Converter/Descrambler Box

You can:

- 1) Record and view any channel including scrambled channels; channel selection must be made at the Cable TV Converter Box.
- 2) Program one channel for unattended recording.

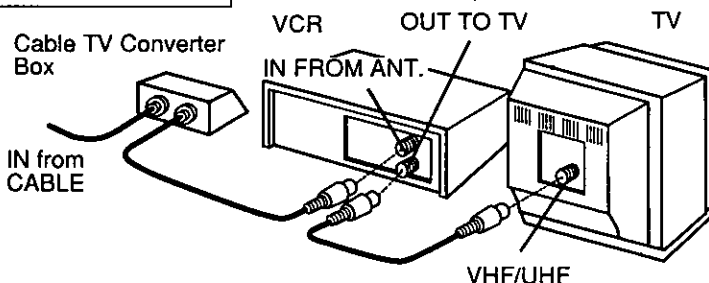

With a (VCR to TV) Converter/Descrambler Box

You can:

- 1) Use your VCR Remote Control to select channels.
- 2) Program unattended recordings of more than one unscrambled channel.

NOTE: You cannot record scrambled channels with this connection.

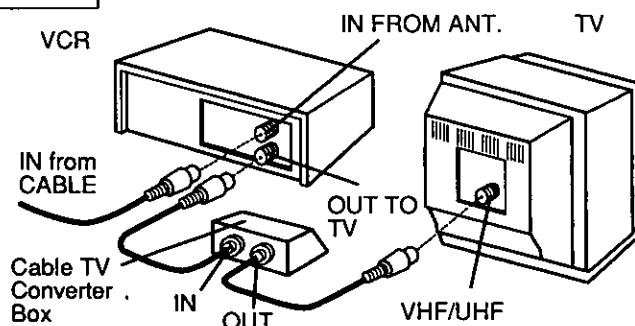

With Two Converter/Descrambler Boxes

If you want to record and view a combination of scrambled and unscrambled channels, you will need additional equipment. This connection requires two converter boxes, an A/B switch, and a 2-way splitter as shown here.

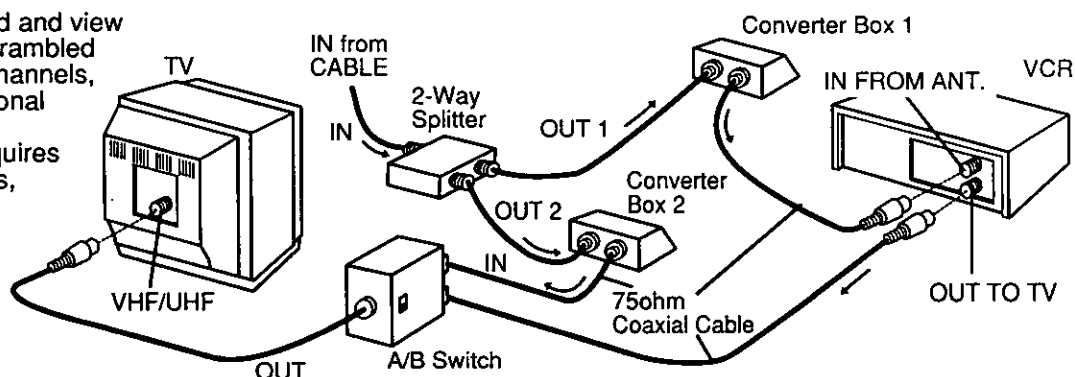

With a DSS Receiver

You can:

- 1) Record and view any channel including scrambled channels; channel selection must be made at the DSS Receiver.
- 2) Program one channel for unattended recording.

NOTE: The DSS receiver must be turned off to view programs from a cable box or antenna. See the DSS manual for details.

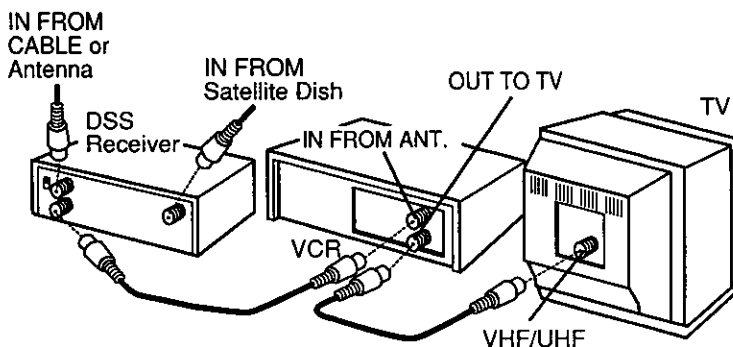

**DSS® is a registered trademark of DIRECTV, INC., a unit of GM Hughes Electronics.

Audio/Video Connections

If your TV has AUDIO IN and VIDEO IN terminals, you can connect your VCR to them to receive a higher quality picture and sound. The antenna-VCR and VCR-TV connection is as shown.

Audio/Video Connections

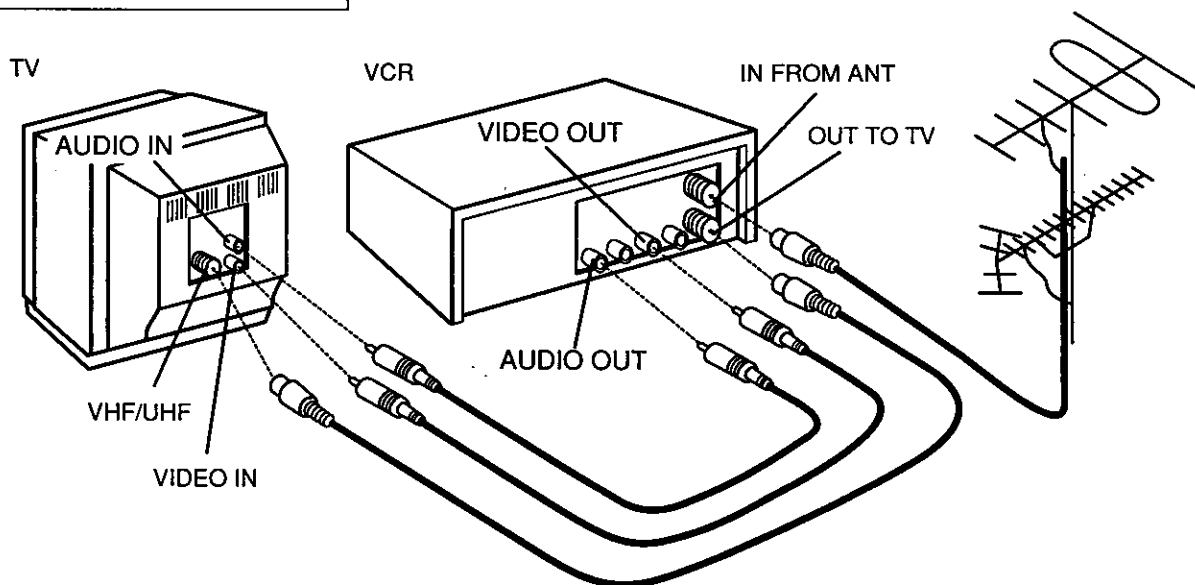

- 1 Connect the VIDEO OUT terminal on the VCR to the VIDEO IN terminal of your TV.
- 2 Connect the AUDIO OUT terminals on the VCR to the AUDIO IN terminals of your TV.
- 3 Set the VIDEO/TV selector of your TV (Monitor/Receiver) to "VIDEO."

NOTE: To use your TV as a VCR monitor, set the VIDEO/TV selector on the TV (Monitor/Receiver) to "VIDEO."

Note to CATV system installer:

This reminder is provided to call the CATV system installer's attention to Article 820-40 of the NEC in USA (and to the Canadian Electrical code in Canada) that provides guidelines for proper grounding and, in particular, specifies that the cable ground shall be connected to the grounding system of the building, as close to the point of cable entry as practical.



One Time VCR Setup

When the VCR power is first turned on, the language select and channel auto set screen appear automatically followed by a prompt to set the clock.

✓ Check list before you begin.

- All TV and VCR connections are made. (See pages 6~9.)

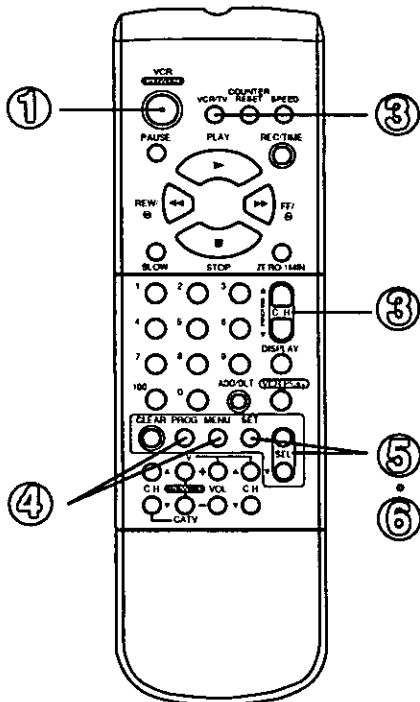
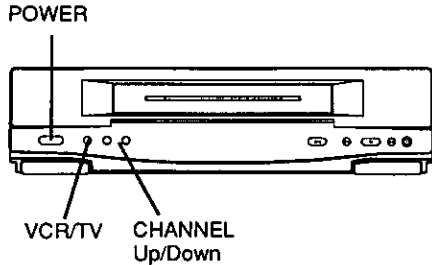

To Set Language, Channel and Clock

①



Turn TV on and VCR on.

②

TV is set to VCR channel (the Same one you set on the back of the VCR CH3 or CH4.) (See page 6.)

③



Push CH ▲ for English on-screen displays.

or



Push CH ▼ for Spanish on-screen displays.

or



Push VCR/TV for French on-screen displays.

- You can also set by using the same buttons on the VCR.

This screen appears a few seconds later. →

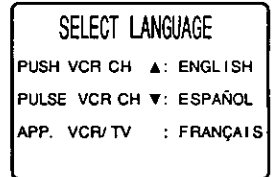

If you set the wrong language, see the "Reset all VCR Memory Functions" section on page 5.

④

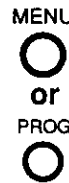

Push MENU for "YES" or PROG for "NO."

- If YES, continue with next step.
- If NO, go to step 8.

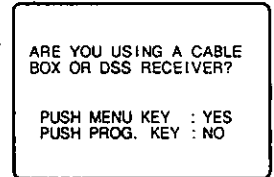

⑤



Push SELECT UP/DOWN and SET to Select your equipment connection method.

- If "CABLE/DSS BOX-VCR-TV", continue with next step.
- If not, go to step 8.

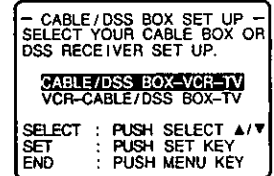

⑥



Push SELECT UP/DOWN and SET to set Cable Box or DSS Receiver output channel (the channel you tune the TV to in order to watch cable or DSS stations).

- If you are using Audio/Video jack connection for your cable box, select and set "VIDEO OUT" as the output channel.

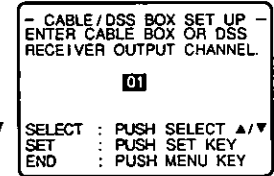

⑦

Turn on the cable box and set it to the PBS channel in your time zone.

- If you use a DSS receiver, it must be turned off.

8



Push CH ▲ to start Channel Auto Set and Clock Auto Set.

CHANNEL/CLOCK AUTO SET
 CONNECT ANTENNA CABLE AND IF YOU USE A CABLE BOX, TUNE IT TO YOUR LOCAL PBS CH THEN...
 PLEASE PUSH CH UP KEY

These on-screen displays will appear in sequence.

- CH AUTO SET PROCEEDING
- CH AUTO SET COMPLETED
- AUTO CLOCK SET PROCEEDING

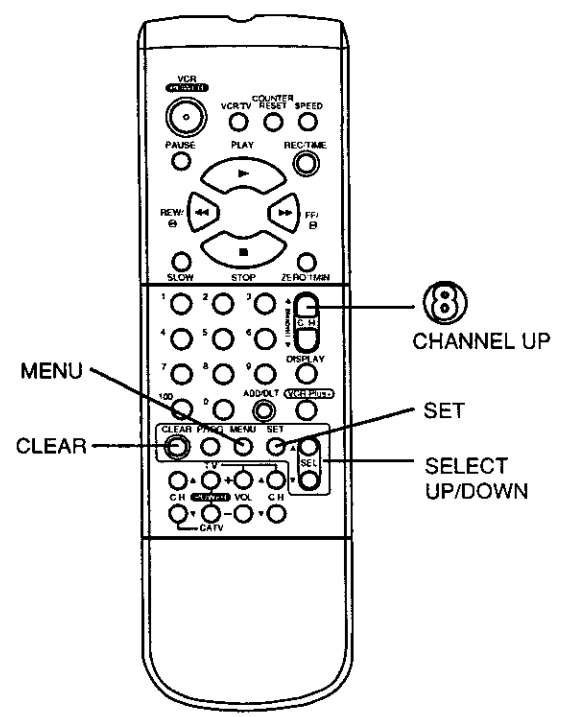
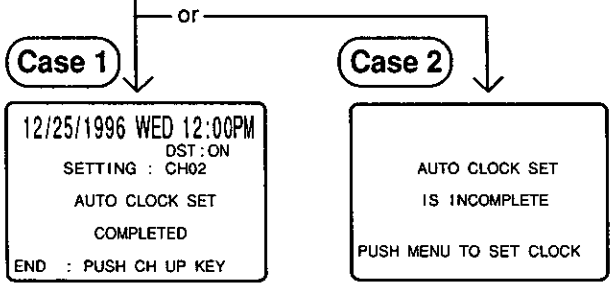

9

Case 1 Confirm that displayed time is correct and push CH ▲ to exit.

If the displayed time and D.S.T. are incorrect, please proceed as follows:

In the rare event that you live close to two different time zones, the VCR may recognize the wrong PBS station as the setting channel. In this case, please do the following:

- 1 Make a note of the SETTING:CH number shown on-screen and push CH ▲ to exit.
- 2 Delete the setting channel from the VCR channel memory. (See the Add or Delete a channel section on page 12.)
- 3 Push the MENU button to display the menu.
- 4 Push the SELECT Up/Down and SET to select "SET CLOCK" and then to select "AUTO SET."
 - If you use a cable box and have multiple PBS stations, tune the cable box to a different PBS station and try auto clock set again using the menu.

Manual Clock Set

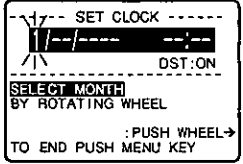
- 1 Push MENU to display the set clock screen.
 
 - "DST:ON" automatically adjusts for daylight saving time. (See page 5.)
- 2 Push the SELECT Up/Down and SET to select and enter the month, date, year, time and D.S.T. (Daylight Saving Time).

To Make Corrections, push the SET or CLEAR button repeatedly to move back or forward to the desired item.

Case 2 If the screen above appears, auto clock set is not available in your area. Please set the clock manually as described at right.

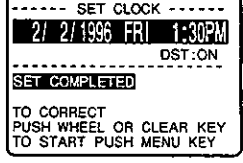
- 3 Push MENU twice to start the clock and exit this mode.
 

IMPORTANT NOTE FOR AUTO CLOCK SET:

- Auto clock set will be performed when the VCR is turned off the first time each day. If you use a cable box and you want auto clock set to be performed, the cable box must be left on and tuned to the PBS channel before the VCR power is turned off.
- If you use a DSS receiver, it must be turned off for auto clock set.
- If you use Audio/Video Jack connection between the VCR and Cable Box or DSS receiver, you must also connect the RF coaxial cable in order to use the auto clock set and channel auto set features.

One Time VCR Setup (continued)

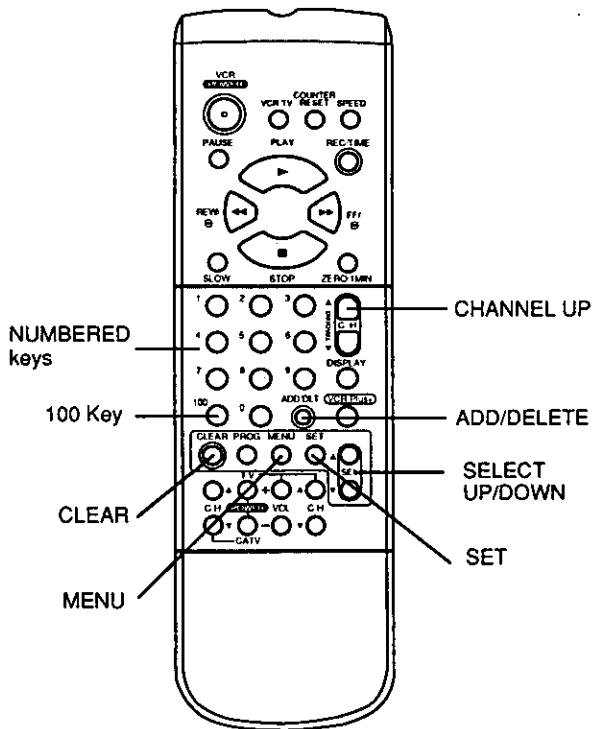

To Replace Channels in Memory

Example, if you have cable installed, etc.

1 Push MENU to display the menu.

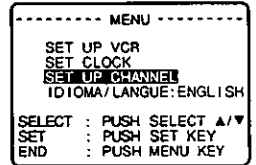

2 Push the SELECT Up/Down and SET to select SET UP CHANNEL from menu, and then to set your antenna system (TV or CATV).

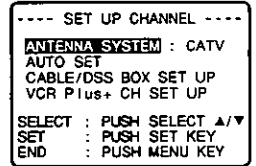

3 Push the SELECT Up/Down and SET to select and set AUTO SET.

- To exit this mode, push MENU.
- If you use a cable box, turn on the cable box and set it to the PBS channel in your time zone.

4 Push CH ▲ to start Channel Auto Set.

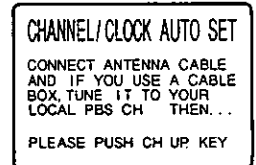

To Change On Screen Display Language

1 Push MENU to display the menu.

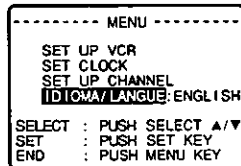

2 Push the SELECT Up/Down to select the language selection item.

(English: LANGUAGE, Spanish: IDIOMA, French: LANGUE).

3 Push the SET to change the language.

- Each push will change the language in the order shown.



4 Push MENU to exit this mode.

To Set or Reset the Clock

In case the clock is wrong, or a power failure occurred.

1 Push MENU to display the menu.

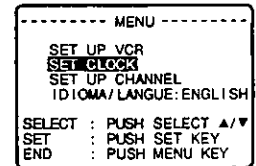

2 Push the SELECT Up/Down and SET to:

- Select SET CLOCK
- Select MANUAL SET
- Set the date, time, and D.S.T. (Daylight Saving Time).

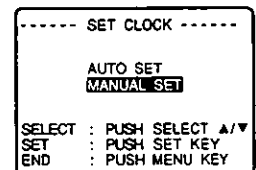

3 Push MENU twice to start the clock and exit this mode.



To Add or Delete a Channel

1 Select a channel using the NUMBERED keys.

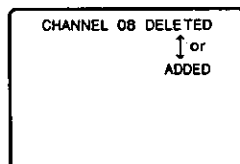

2 Push ADD/DLT to add or delete the channel.

- To select a deleted channel, use the NUMBERED keys on the remote control. Deleted channels will flash in the Multi Function Display on the VCR when selected.

When Using the 100 key

When selecting CATV channels 100 to 125 with the NUMBERED keys, first push the 100 key and then enter the remaining two digits.

For example, to select channel 125: Push NUMBERED keys 100, then 2, then 5.



- This VCR will accurately maintain its calendar up to Dec. 31, 2014, 11:59PM.
- Normal TV or Cable channels are automatically selected and placed in memory depending on how your VCR is hooked up.
- By pushing the SET or CLEAR button repeatedly, you can skip forward or backward over correct entries and go directly to a specific item.

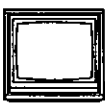

On Screen Displays (OSD)

Channel & Function Display

Whenever the channel is changed, the Channel number followed will appear for a few seconds on-screen. (Some station names may also appear.)

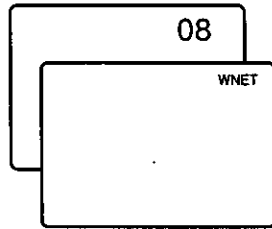

When a function button is pushed (PLAY, FF, etc.) the VCR mode will be displayed.

Menu Screen

1 Push MENU to display the menu.

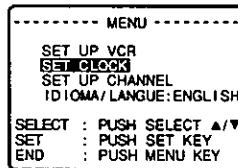

2 Push SELECT UP/DOWN and SET to make your selection.

- To get the most from each feature, it is recommended that you read the Operation Manual before attempting any operation.

Warning and Instruction Displays

These displays will alert you to a missed operation or provide further instructions.

If no active channels are found for CHANNEL MEMORY...

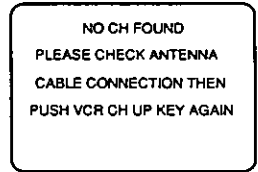

If you attempt to set or review a Timer Recording and the Clock is not set...

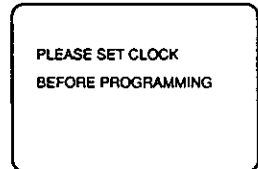

If a Timer Program was not completed before exiting the Program mode...

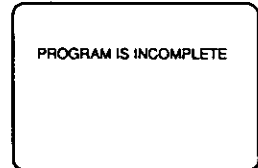

After a Timer Program has been set...



If you Push REC on the remote control or REC and PLAY on the VCR, and a cassette is inserted with no record tab...

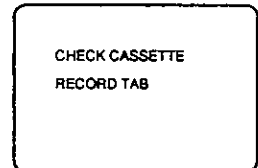

If you Push PLAY, FF, REW, or REC on the remote control or if you push REC and PLAY, PLAY, FF, REW, or REC on the VCR without a cassette inserted...

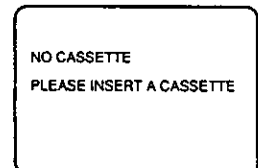

If you Push POWER or STOP during a Timer Recording... (visible in VCR mode only)

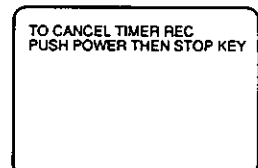

VCR Status & Clock Display

Push DISPLAY to display and remove the overlay shown below.

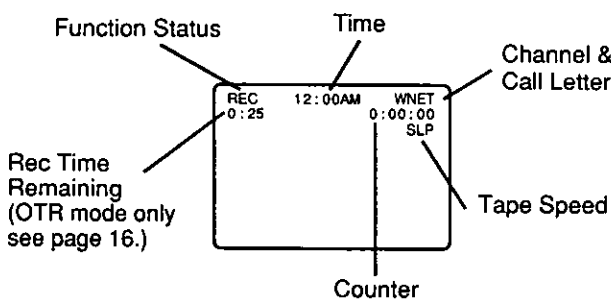

Blank Tape and will be Blue Screen

If a blank section of tape is encountered in the Play mode or the channel you select has no broadcast, the TV screen will change to a solid blue field. The screen will remain blue until a recorded signal is again detected or an active channel is selected.

▶ Playback a Tape

✓ Check list before you begin

- All connections are made. (See pages 6~9.)
- TV and VCR are plugged in.
- TV is turned on and set to the VCR channel (CH 3 or 4).

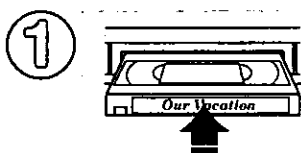
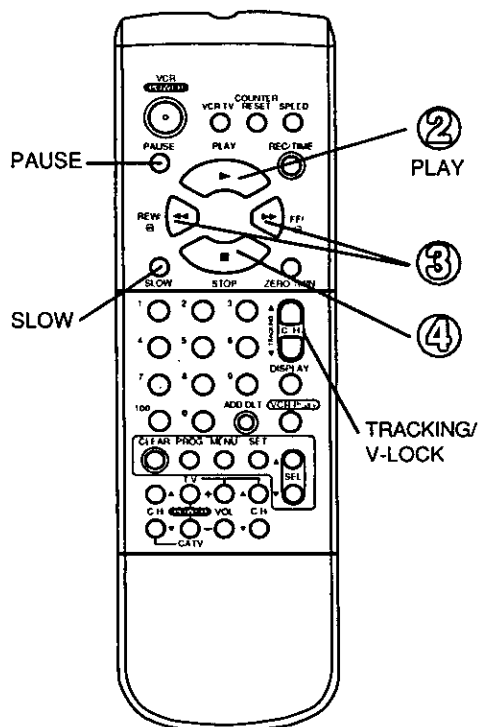
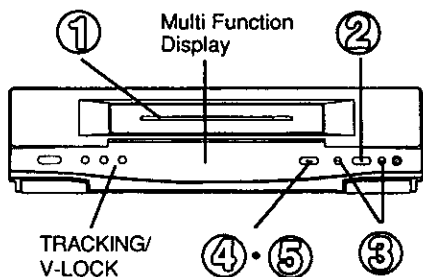

Insert a cassette.
• VCR power comes on automatically.

This indicator lights in the Multi Function Display.

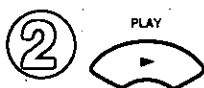
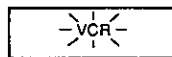

Push **PLAY** to start playback.

- Playback begins automatically if cassette has no record tab.

(VCR or Remote Control)

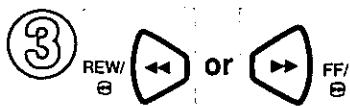

Push **REW** or **FF** to quickly locate a scene.

- SP mode tapes have a search speed of 9 times and SLP mode tapes 27 times the normal speed.
- Some noise bars will appear during search.

(VCR or Remote Control)



Push **STOP** to stop playback.

(VCR or Remote Control)



Push **STOP/EJECT** to eject the cassette.

- This button only on the VCR.

Special Effects During Playback

These features work best in SP or SLP mode. The sound will be muted. (After the VCR is in the Still or Slow mode for 3 minutes, it will go into the Stop mode automatically to protect the tape and video head.)

Slow Motion Playback

Push **SLOW** to start and **PLAY** or **SLOW** to release the Slow mode.

Still (Freeze) Frame Picture

Push **PAUSE** to freeze and release the picture.

- To reduce picture noise:
Place the VCR in Slow motion mode. Use **CH (TRACKING)** ▲/▼ to clear up the picture, then push **PAUSE**.

Frame by Frame Advance

While in Still mode, hold down the **SLOW** button to advance the still picture one frame at a time. Push **PAUSE** to release.

Feature for a Quality picture

Digital Auto Picture

This feature automatically controls the video output signal for less noise depending on the tape condition.

Digital Auto Tracking

This feature continuously analyzes the signal and adjusts for optimum picture quality.

Manual Tracking Control

Use during Playback and Slow Motion mode to reduce picture noise. Push **CH (TRACKING)** ▲/▼ buttons until the picture clears up. To return to Auto Tracking mode, push **POWER** off and then on again.

V-Lock Control

In Still mode, the **CH (TRACKING)** ▲/▼ buttons operate as a V-Lock control to reduce jitter. Push ▲/▼ until the picture is stabilized.

Caution:

Please inspect your cassette tape for any loose or peeling labels as it may become jammed in your unit.

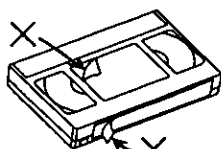



Tape Operation

Your VCR is equipped with several time saving features as well as convenient automatic functions which make tape operation easier than ever.

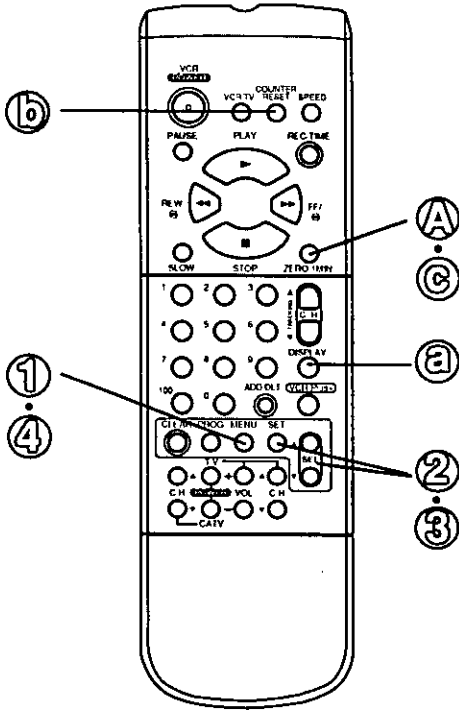

Repeat Play

You can set your VCR up to play a recording over and over.

- ① MENU ○ Push MENU to display the menu.

----- MENU -----

SET UP VCR

SET CLOCK
SET UP CHANNEL
ID10MA/ LANGUAGE: ENGLISH

SELECT : PUSH SELECT ▲/▼
SET : PUSH SET KEY
END : PUSH MENU KEY
- ② SEL ○ Push SELECT UP/DOWN and SET to select SET UP VCR.

----- SET UP VCR -----

REPEAT PLAY : ON
BEEPER : ON
INPUT SELECT : TUNER

SELECT : PUSH SELECT ▲/▼
SET : PUSH SET KEY
END : PUSH MENU KEY
- ③ SEL ○ Push SELECT UP/DOWN to select "REPEAT PLAY", and then push SET to select "ON" or OFF.*

 - The VCR plays to the end of a tape, or until a blank portion of 30 seconds or more is reached. (Erased portions of tape are not considered blank.) The tape is then automatically rewound and played again and again until Repeat Play is cancelled. All function buttons (REW, FF, etc.) are operational during Repeat Play.
- ④ MENU ○ Push MENU twice to leave this screen.

Auto Operation Functions

Auto Playback

When a tape is inserted, the power comes on (Auto). If the record tab* is removed, playback begins (Auto).

Auto Rewind

After a tape reaches its end during playback, fast forward or manual record, the VCR will rewind and go into Stop mode.

Playback Auto Eject

After a tape without a record tab* is played to its end, the VCR will rewind and then eject the tape.

Memory Rewind Off

When the POWER button is pushed during rewind, the VCR will turn off after rewind is complete.

Eject Cassette

A cassette may be ejected with power on or off.

* For record tab information, see page 5.

One Minute Skip

With this feature, you can skip over commercials recorded on a tape.

- A ○ ZERO/1MIN ○ Push ZERO/1MIN in Play mode.

 - The VCR will go into FF search mode and skip over 60 seconds of recorded time. Then, normal playback will resume.

Zero Search

You can reset the Time Counter to zero and then return to that point.

- a DISPLAY ○ Push DISPLAY to display the Time Counter overlay.

STOP 12:00AM CH08
0:00:30
SLP
- b COUNTER RESET ○ Push COUNTER RESET to reset the Time Counter.

 - This may be done at as many places as you wish on the tape.

STOP 12:00AM CH08
0:00:00
SLP
- c ZERO/1MIN ○ Push ZERO/1MIN in Stop mode.

 - The VCR will go into FF or REW mode and stop at the last point the Time Counter was set to 0:00:00.

Record On a Tape

✓ Check list before you begin.

- All connections are made. (See pages 6~9.)
- VCR is Plugged in.
- TV is turned on and set to the VCR channel (CH3 or CH4).

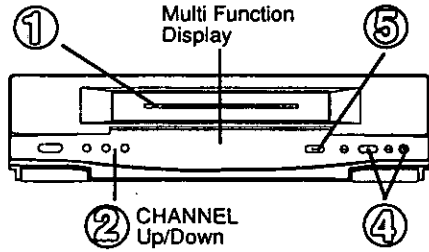

- ① Insert a cassette with record tab.

- VCR power comes on automatically.

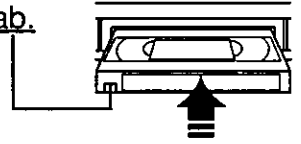

- ② Push VCR CH ▲/▼ or NUMBERED keys to select a channel.



- Or, push CHANNEL ▲/▼ on the VCR.
- Holding down the CH ▲/▼ buttons will increase the channel search speed.
- To record from an outside source, push CH ▲/▼ to select "LINE" (see next page).

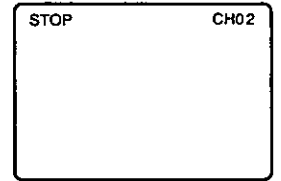

- ③ Push SPEED to change current recording speed.



- SP = Standard Play,
- LP = Long Play,
- SLP = Super Long Play.

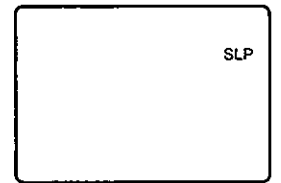

- ④ Push REC/TIME to start recording.



- Or, push PLAY and REC/TIME on VCR.
- Push PAUSE to pause a recording in progress. (After the VCR has been in Pause mode for 5 minutes, it will stop automatically to protect the tape and video head.)

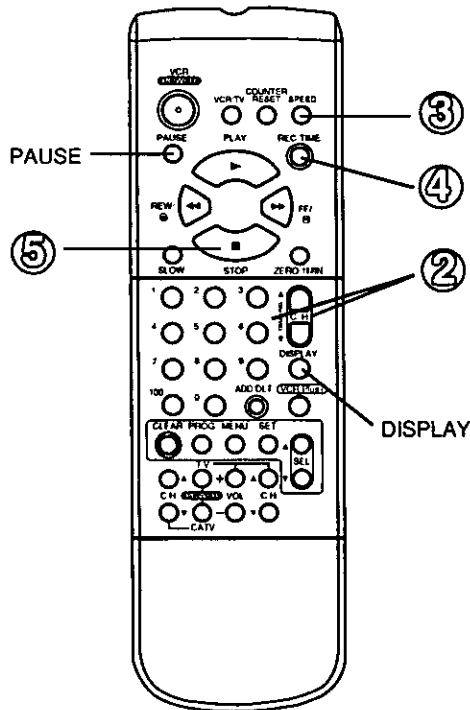

One Touch Timer Recording (OTR)

The VCR starts recording and turns itself off at a preset time.

Continue to push REC/TIME to set the recording length. Each push will change the stop time as shown.

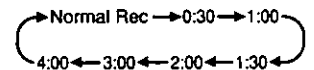

- "TIMER" lights in the Multi Function Display.
- The recording time remaining appears if the DISPLAY button is pushed during OTR mode.

- ⑤ Push STOP to stop recording.



- Or, push STOP on the VCR.

Selecting the Input Mode

- 1 Push the MENU button to display the menu.
- 2 Push the SELECT Up/Down and SET buttons to select "SET UP VCR."

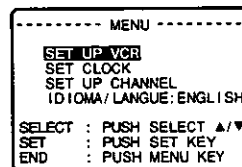

- 3 Push the SELECT Up/Down to select "INPUT SELECT" and then, push to the SET button to choose TUNER or LINE.

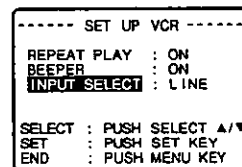

- You can also select "LINE" using the CH ▲/▼ buttons. The numbers will change in the order shown.

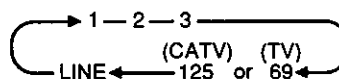

- When LINE is selected, "L" is displayed in the Multi Function Display.

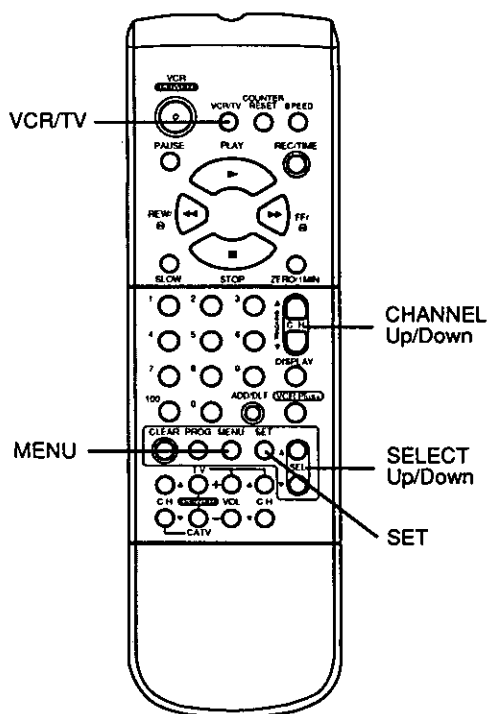
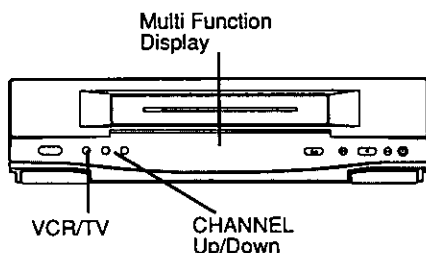

Watching Another TV Program

- 1 Push VCR/TV while recording is in progress to turn off the VCR indicator in the Multi Function Display.
- 2 Use the TV channel controls to select a program. The VCR will continue to record your program while you watch any channel you choose.
 - Switch back and forth between the recording and viewing channel with the VCR/TV selector.

Selecting Channels at the VCR

- 1 Turn TV on.

- If indicator doesn't light, push VCR/TV to turn it on.

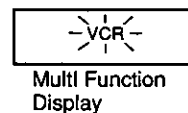

- 2 Use CH ▲/▼ buttons to select channels for viewing or recording.

- To resume TV control channel selection, push VCR/TV to turn VCR indicator off, or simply turn VCR off.



Timer Recording

Your VCR can be set up to do a recording while you are away or otherwise occupied. Up to 8 programs can be placed in memory. You can choose to record one time, daily, or weekly.

Check list before you begin.

- All connections are made. (See pages 6-9.)
- TV and VCR are plugged in and turned on.
- VCR/TV selector is set to "VCR."
- Clock is set to correct time.
- Record tab in place. (See page 5.)

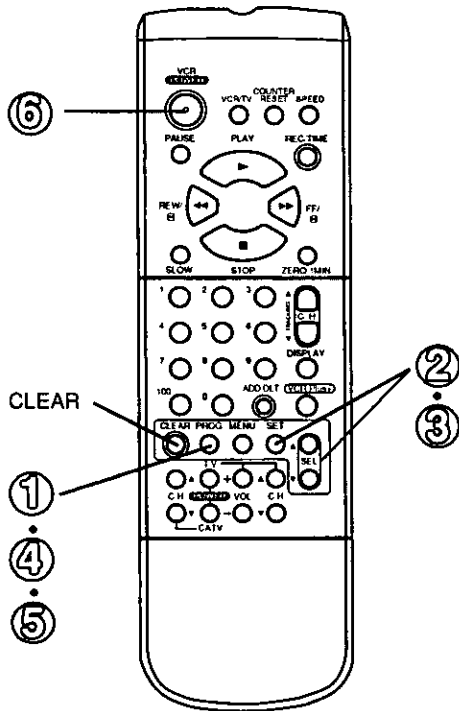
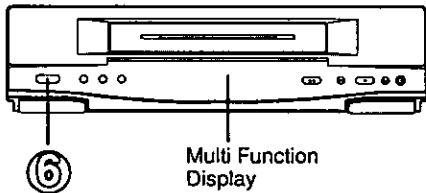

Push PROG to display the program screen.

- If a program is already in memory, push the SELECT Up/Down and SET buttons to select an unused program number.

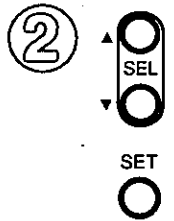
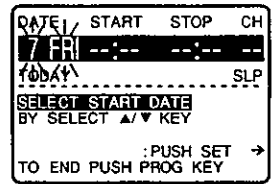

Push SELECT UP/DOWN to select the DATE, and then push to SET to enter it.

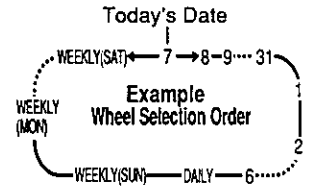

Daily and Weekly Timer Recording

If you want the program to be recorded daily (Mon thru Fri), enter DAILY in place of the DATE in step 2. If you want the recording to be on a weekly basis, enter WEEKLY MON, TUE, etc..

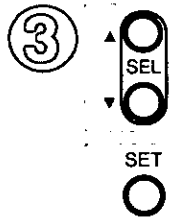
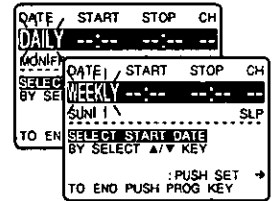

Push SELECT UP/DOWN and SET to set remaining items at right.

- Remaining Items to be set:**
- START time
 - STOP time
 - CH(annel) number, or LINE for outside source recording.
 - Speed (SP, LP, SLP).

To Make Corrections

Repeatedly push the SET button to move forward, or the CLEAR button to move back to the desired item. Then, select and set continue with step 3.



Push PROG to end the program.

- If you want to enter more programs, select a blank program number with the SELECT Up/Down and SET and repeat steps 2 and 3.

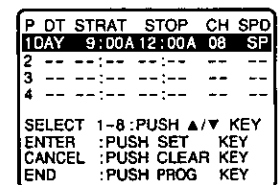

Push PROG to exit this mode.



Push POWER off to set the timer.

- When recording programs via a cable box, make sure the cable box is left on and tuned to the desired channel.

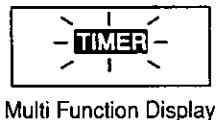

Important notes when using a DSS receiver

- When recording programs via a DSS receiver, the DSS receiver must be left on.
- When recording programs via an antenna or cable, the DSS receiver must be turned off.



- If the cassette record tab is missing at the time the POWER is turned OFF, the tape ejects and the TIMER indicator flashes in the Multi Function Display.
- If the start times of two programs overlap, the lower numbered program will have priority.
- If the start time for a timer recording comes up during a normal recording or One Touch Recording (page 16), the timer recording will not be performed.
- If there is a power interruption of more than one minute, the recording will not be performed or continue.
- If "PROGRAM IS INCOMPLETE" appears on-screen in step 4, check all entries and make necessary corrections.

Cancel a Timer Recording: Recording is in progress

- 1 Push the POWER button to release the VCR from timer mode.
- 2 Push the STOP button within 10 seconds of pushing the POWER button to cancel the recording. The TIMER indicator goes out in the Multi Function Display.

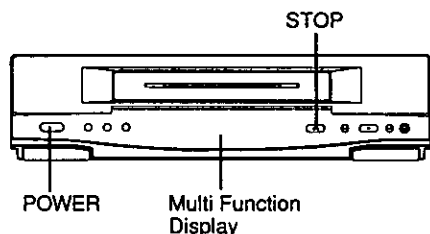

Replace Program Contents: Recording is not in progress

- 1 Push the PROG button to display all currently set programs.
- 2 Push the SELECT Up/Down and SET buttons to select and enter the desired timer recording. (See page 18.)
- 3 Push the SELECT Up/Down and SET buttons to select and enter replacement information.
- 4 Push the PROG button to exit this mode and return to the normal TV screen.

P	DT	STRAT	STOP	CH	SPD
1	--	--	--	--	--
2	8	10:00P	12:00P	125	SLP
3	10	8:00P	9:00P	10	SP
4	SU	9:00P	10:00P	L	SLP

SELECT 1-8 : PUSH ▲/▼ KEY
 ENTER : PUSH SET KEY
 CANCEL : PUSH CLEAR KEY
 END : PUSH PROG KEY

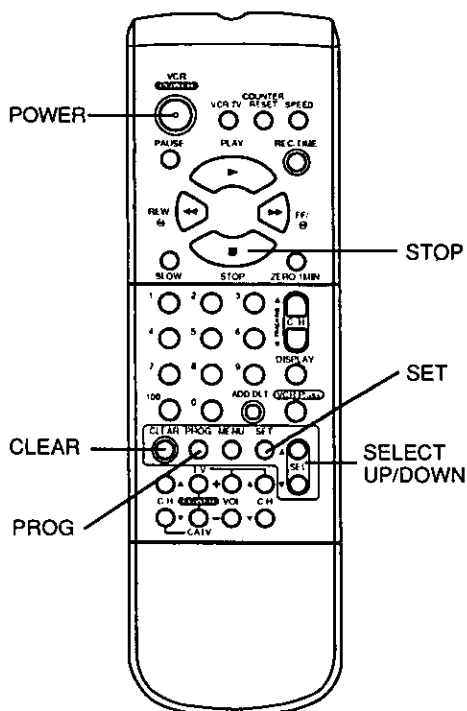

DATE	START	STOP	CH
8 SAT	10:00P	12:00P	125
12/1	--	--	SLP

SELECT START DATE
 BY SELECT ▲/▼ KEY
 ←PUSH CLEAR : PUSH SET →
 TO END PUSH PROG KEY

Review or Clear Program Contents: Recording is not in progress

- 1 Push the PROG button to display all currently set programs.
- 2 Push the SELECT Up/Down buttons to select the desired program number.
- 3 Push the CLEAR button to clear the program.
- 4 Push the PROG button to exit this mode and return to the normal TV screen.

P	DT	STRAT	STOP	CH	SPD
1	DAY	9:00A	12:00A	08	SP
2	8	10:00P	12:00P	125	SLP
3	10	8:00P	9:00P	10	SP
4	SU	9:00P	10:00P	L	SLP

SELECT 1-8 : PUSH ▲/▼ KEY
 ENTER : PUSH SET KEY
 CANCEL : PUSH CLEAR KEY
 END : PUSH PROG KEY

P	DT	STRAT	STOP	CH	SPD
1	--	--	--	--	--
2	8	10:00P	12:00P	125	SLP
3	10	8:00P	9:00P	10	SP
4	SU	9:00P	10:00P	L	SLP

SELECT 1-8 : PUSH ▲/▼ KEY
 ENTER : PUSH SET KEY
 END : PUSH PROG KEY



Timer Recording Using VCR Buttons

A timer recording can be set up using the buttons on the VCR. If necessary, the clock can also be set.

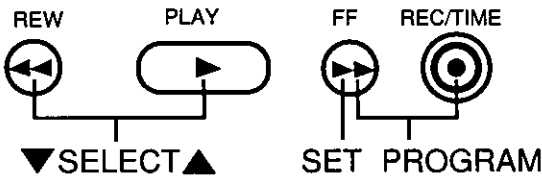
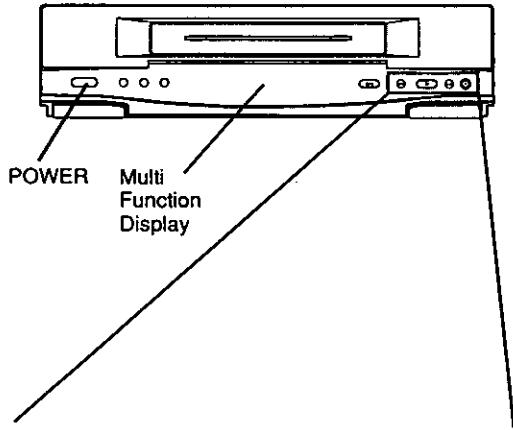

1



Hold down REC/TIME.

and



Push FF to enter the program mode.

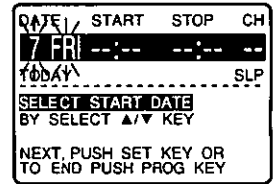

- If the clock is not set, pushing these buttons will display the SET CLOCK screen. In this case, proceed with steps 2 and 3 to set the clock and then steps 2-6 to set a timer recording.

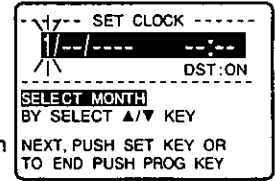

- Once the VCR is in the Program mode, the PLAY, REC, FF, and REW buttons on the VCR operate only as specified above.

2



or

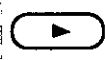

Push REW or PLAY to make your selection.

(for down)

(for up)

3



Push FF to set and move on to the next item.

- Push SET (FF) repeatedly to move to a particular item for setting or correction.

Items to be Set:

- recording DATE
- START time
- STOP time
- CH(annel), or LINE
- SPEED (SP, LP, SLP)

When the program is completed...

4



and



Push REC/TIME and FF to display program contents.

(at the same time)

To set the next program,

repeat steps 2, 3, and 4 before continuing with step 5.

5



and



Push REC/TIME and FF to exit this mode.

(at the same time)

6



Push POWER off to set the timer.



Multi Function Display

- It is not possible to clear a timer program using the VCR buttons. Please use the Remote Control.
- When recording programs via a cable box, make sure the cable box is left on and tuned to the desired channel.



Copying Your Tapes (Dubbing)

Connections you'll need to make.

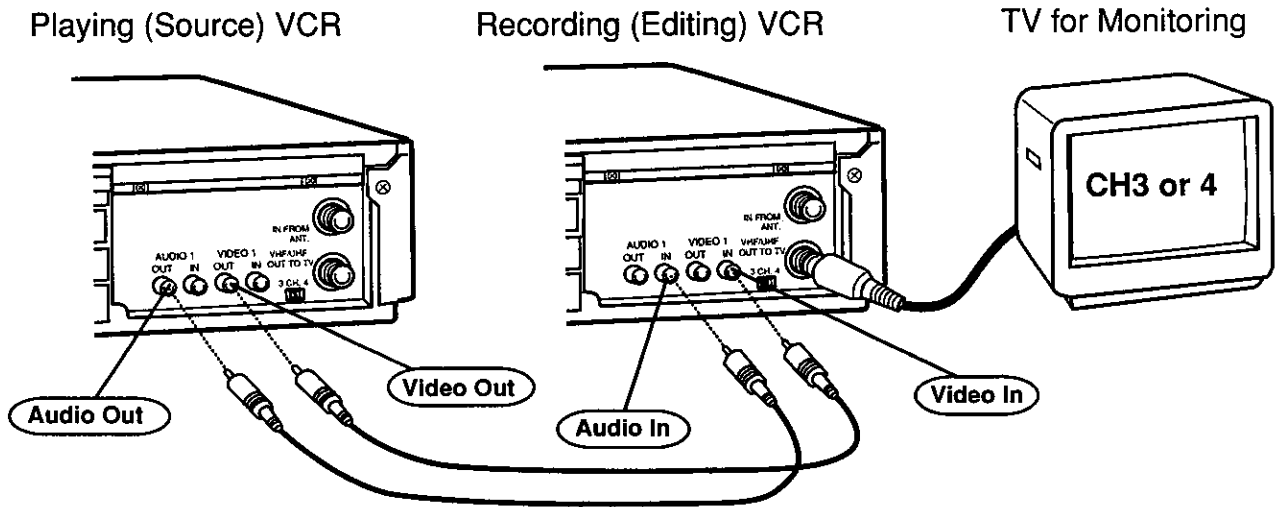

- 1 Insert a pre-recorded tape into the Playing (Source) VCR.

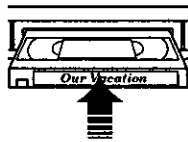

- 5 Push **REC** and **PLAY** at the same time on Recording VCR. Push **PAUSE** immediately.

- 2 Insert a blank tape with record tab into the Recording (Editing) VCR.

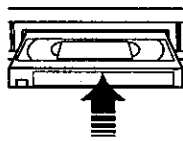

- 6 Push **PAUSE** on both VCRs (at the same time), to begin copying.

Edit Out Unwanted Parts of the original recording by using the **PAUSE** button (on the Recording unit) while copying is in progress.

- 3 Select Input "**LINE**" on the Recording (Editing) VCR. (See "Selecting the Input Mode" on page 17.)

- 7 Push **STOP** on both VCRs to stop copying.

- 4 Push **PLAY** on Playing VCR. Push **PAUSE** at the point you want to start copying.

To Monitor the Re-Recording

- 1 Turn the TV on and select its VCR channel (CH3 or CH4) on the Recording VCR.
- 2 Set the VCR/TV selector on the Recording VCR to the "VCR" position.

Caution:

Unauthorized exchanging and/or copying of copyrighted recordings may be copyright infringement.



VCR Plus+ Set Up

This setup is for VCR Plus+ and timer programming only.

In order for your VCR to do a VCR Plus+ recording (see top of page 23 for explanation of VCR Plus+), or a timer recording of cable stations, some setup is required. At first, find the antenna or cable connection that matches yours. Then, follow the instructions below your connection.

Choose your Connection Type

(Then, follow the instructions under the diagram.)

Connection Type A

<CABLE BOX → VCR → TV>

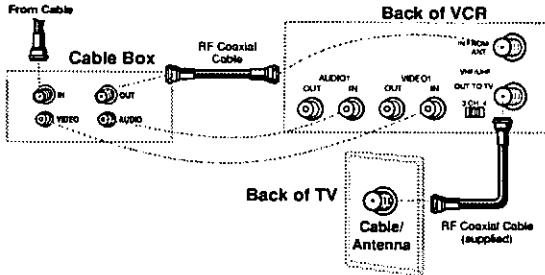

<ANT/CABLE BOX → DSS BOX → VCR → TV>

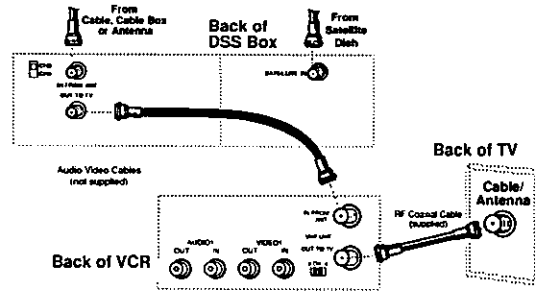

If your system looks like this diagram, do the following.

1. Complete the "Cable Box Set Up" section at right.
2. Skip page 23 and go directly to page 24 for VCR Plus+ Programming.

Connection Type B

<VCR → TV>

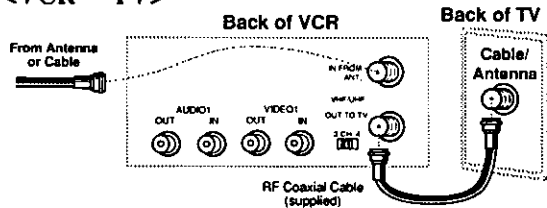

<VCR → CABLE BOX → TV>

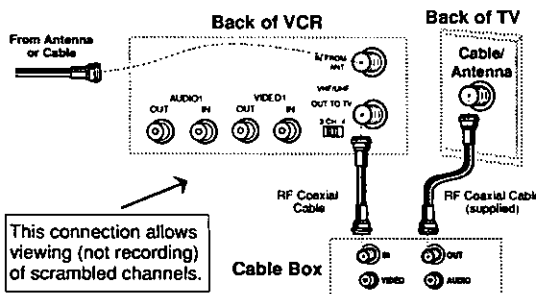

This connection allows viewing (not recording) of scrambled channels.

If your system looks like one of these, do the following.

1. Skip the "Cable Box Set Up" section at right and turn to page 23.
2. Complete the "VCR Plus+ Channel Set Up" section on page 23.
3. Turn to page 24 for VCR Plus+ Programming.

Cable Box Set Up

For connection A (see left) only

① MENU

Push MENU to display the menu.

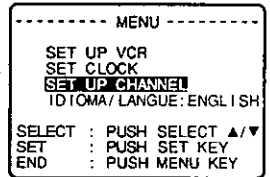

② SEL

Push SELECT UP/DOWN and SET to select SET UP CHANNEL.

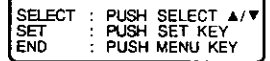

SET

③ SEL

Push SELECT UP/DOWN and SET to select CABLE/DSS BOX SET UP.

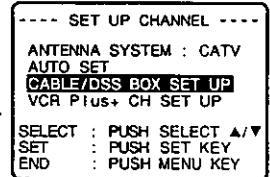

SET

④

Select YES if you are using a cable box and continue with step 5.

Select NO if you are not using a cable box. Then, push MENU twice and turn to page 23.

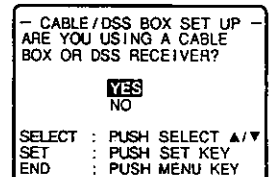

⑤ SEL

Push SELECT UP/DOWN and SET to select your cable box set up.

If you selected CABLE/DSS BOX → VCR → TV, continue with step 6. If not, push MENU twice and turn to page 23.

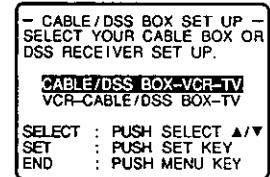

SET

⑥ SEL

Push SELECT UP/DOWN and SET to change the output channel number.

Number shown is example only. You are sure to enter your cable box output channel number.

- If necessary, refer to your cable box manual.
- If you are using Audio/Video jack connection for your cable box, select and set "VIDEO OUT" as the output channel.

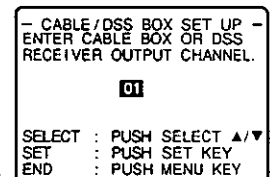

⑦ MENU

Push MENU to confirm your entry.

This display appears for five seconds. (Channel shown is example only)

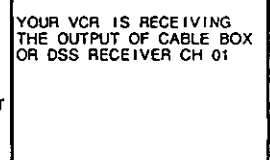

⑧ MENU

Push MENU twice to return to the normal screen.

Then, go directly to VCR Plus+ Programming on page 24.

VCR Plus+ programming allows you to set most items of a timer recording by simply entering a special code found in *TV GUIDE* magazine as well as the TV listings in selected newspapers. In order for the VCR to read this special code, some set up is required. A Guide (VCR Plus+) channel number is assigned to each local broadcast and cable station. Because this number sometimes differs from the channel your TV receives the station on, it is necessary to program the VCR with local channel information.

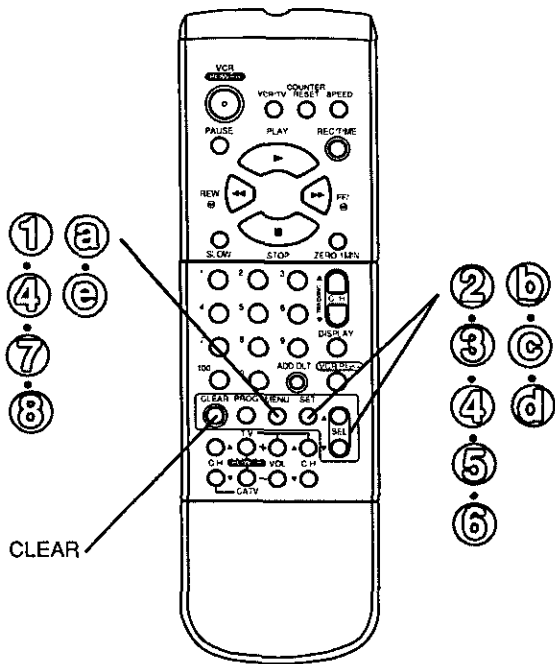

VCR Plus+ Channel Set Up (For connection B on page 22 only)

a MENU Push MENU to display the menu.

b SEL Push SELECT UP/DOWN and SET to select SET UP CHANNEL.

SET

----- MENU -----

SET UP VCR
SET CLOCK
SET UP CHANNEL
ID10MA/LANGUE: ENGLISH

SELECT : PUSH SELECT ▲/▼
SET : PUSH SET KEY
END : PUSH MENU KEY

c SEL Push SELECT UP/DOWN and SET to select VCR Plus+ CH SET UP.

SET

----- SET UP CHANNEL -----

ANTENNA SYSTEM : CATV
AUTO SET
CABLE/DSS BOX SET UP
VCR Plus+ CH SET UP

SELECT : PUSH SELECT ▲/▼
SET : PUSH SET KEY
END : PUSH MENU KEY

IMPORTANT NOTE:
For this step, use the list you prepared. You may leave lines blank if, you don't receive that station, or the GUIDE CH number and the CATV (or TV) CH numbers are the same.

d SET Push SET to move the shaded area on the right side.

VCR Plus+ CH SET UP

GUIDE CH	CATV CH
→ 01 02	--

SELECT : PUSH SELECT ▲/▼
SET : PUSH SET KEY
END : PUSH MENU KEY

Then, push **SELECT UP/DOWN** to change CATV or TV CH number.
Next, push **SET** to enter CATV or TV CH number.
Now, push **SELECT UP/DOWN** to continue. Repeat this operation until the list is complete.

To Make Corrections
Rotate and push the Wheel to select the incorrect CATV or TV CH number. Then, push CLEAR to delete the numbers. Now, use the Wheel to re-enter the channel.

e MENU Push MENU twice to exit the VCR Plus+ CH SET UP mode.

NOTES

- Make your entries within 60 seconds or the VCR will leave this mode.
- Once local channels have been programmed, they will stay in memory, even in the case of a power failure.

Channel Set Up Preparations

NOTE: Complete the steps on this page if your VCR hook-up resembles "B" on page 22.

Prepare a list like the example below. This list will help you smoothly enter the information needed in step "d" at right.

You will need the following to complete the list:

- A line up of normal and/or cable stations you receive along with the channel numbers your TV receives them on. A cable channel line-up chart is supplied by your cable company.
- A list of Guide (VCR Plus+) channel numbers assigned to the stations you receive. This list is available in *TV Guide* and the TV listings found in selected newspapers.

- 1 Make a chart with 3 columns like the example below. In the left column, fill in the name or call letters of the stations you receive.
- 2 In the middle column, fill in each station's assigned Guide (VCR Plus+) number found in *TV Guide*, newspapers, etc.
- 3 In the right column, fill in the channel number that your TV receives the station on from your channel line-up.

EXAMPLE ONLY

Broadcast or Cable Station Name	Assigned Guide (VCR Plus+) channel no.	Channel no. your TV receives the station on
HBO	33	15
Nickelodeon	38	20
CBS	04	04
FOX	11	



VCR Plus+ Programming

✓ Before you begin, make sure...

- The clock is set.
- VCR Plus+ Set Up is complete (See pages 22, 23).



⑥ Multi Function Display

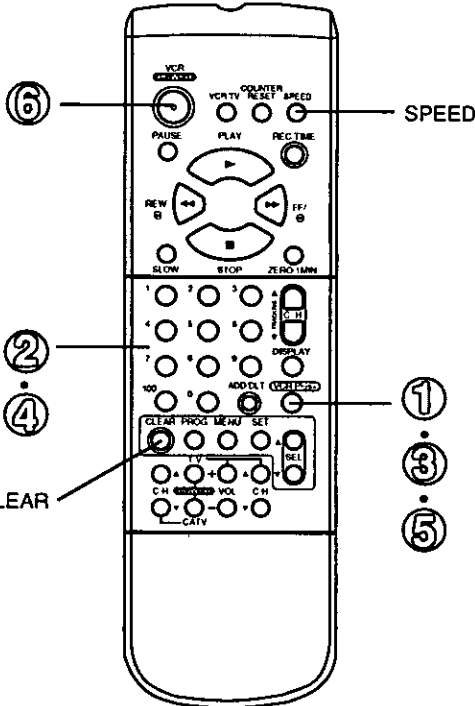

① Push VCR Plus+ to display the VCR Plus+ screen.

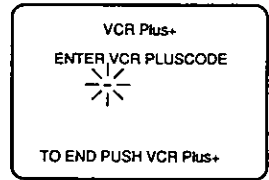

② Push the Numbered Keys to enter the PlusCode number.

- Refer to your local TV listings.

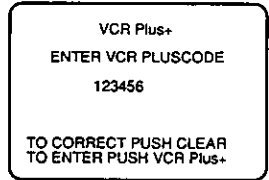

To make corrections

Push the CLEAR button repeatedly to delete the PlusCode number. Then, enter the correct number.

③ Push VCR Plus+ to lock in your program.

④ Push 1, 2 or 3 Key to select the program type.

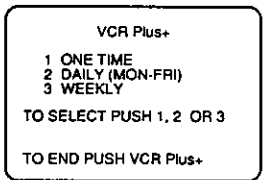

To change the recording speed:
Press the SPEED button for SP, LP or SLP.

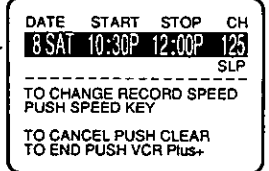

To cancel program contents:
Press the CLEAR button.

- If you use "A" connection on page 20, the channel shown in the on-screen display in this step will always be the cable box output channel number.

⑤ Push VCR Plus+ to complete the program.

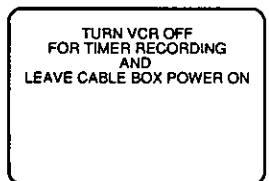

- If you're using a Cable Box, make sure that it is tuned to the desired channel and the power is left on for timer recording.

- This display may differ depending on your cable box hook-up.

⑥ Push VCR POWER off to set the timer.

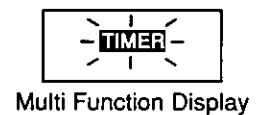

Use normal Timer Recording steps if:

- the PlusCode for a program is not listed.
- you anticipate the program, such as a sporting event, to run over the scheduled stop time.

See page 19 to:

- Cancel a timer recording in progress
- Replace program contents
- Review or Clear program contents once set

Important notes when using a DSS receiver

- When recording programs via a DSS receiver, the DSS receiver must be left on.
- When recording programs via an antenna or cable, the DSS receiver must be turned off.

VCR Plus+ and PlusCode are trademarks of Gemstar Development Corporation. The VCR Plus+ system is manufactured under license from Gemstar Development Corporation.



- For a list of publications that carry the PlusCode numbers in your area, call 1 - 800 - 258 - 4827.
- You can obtain unlisted PlusCode numbers by calling 1 - 900 - 454 - 7587. Call costs approximately \$.95 per minute.
- VCR PlusCodes can not be used to program the VCR to record DSS channels.
- Avoid overlapping program times.
- An on-screen display will indicate if an invalid PlusCode number has been entered.
- An on-screen display will indicate when all timer programs are full.



Special VCR Features

✓ Check list before you begin.

- All connections are made. (See pages 6~9.)
- VCR is Plugged in.
- TV is turned on and set to the VCR channel (CH3 or CH4).

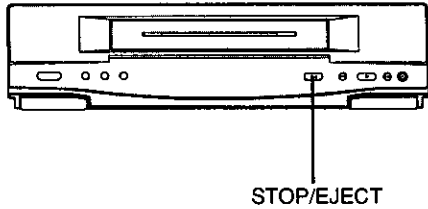

VCR Lock Feature

When activated, this feature prohibits all operations except for timer recording, and tape eject. This is useful to prevent misoperation and protect your VCR from curious children.

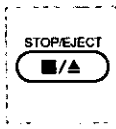

Hold down STOP/EJECT on the VCR for 7 seconds during Stop, or Power OFF mode.

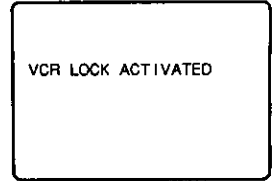

To Cancel the VCR Lock feature,



Hold down STOP/EJECT on the VCR for 7 seconds again during Stop, or Power OFF mode.

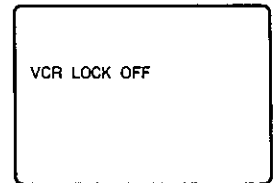

- VCR Lock mode is cancelled automatically after 24 hours when the clock is set.

Warning Beeper Feature

When you select BEEPER ON as described below, a short warning will sound each time an invalid entry or operation is made and a timer program is set.

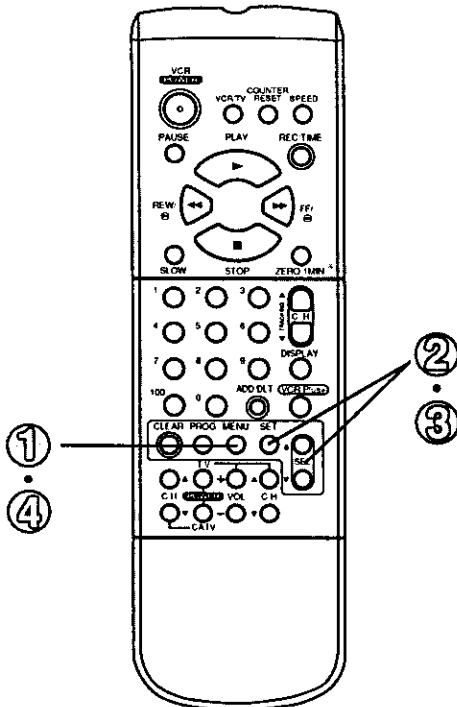

1



Push MENU to display the menu.

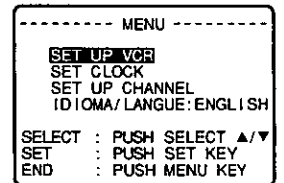

2



Push SELECT UP/DOWN and SET to select "SET UP VCR".

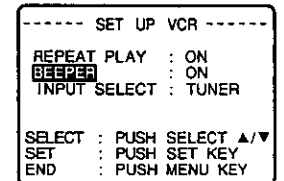

3



Push SELECT UP/DOWN to select "BEEPER", and then push SET to select "ON" or "OFF".



4



Push MENU twice to exit this screen.

More You Can Do

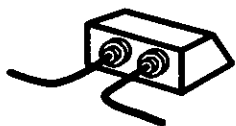

Multi-Brand Control Feature

The Remote Control may be set up to control some of the functions on your TV or Cable Box.

TV Brand Code Numbers

Panasonic	01, 02
Quasar	01, 02
RCA	03
GE	03
Zenith	04
Magnavox	05
Sylvania	05
Sharp	06, 07
Sony	08
Toshiba	09
Sanyo	10
Fisher	10
JVC	11
Hitachi	12
Mitsubishi	13
Samsung	14
Gold Star	15, 16, 17

Cable Box Brand Code Numbers

Archer	01, 29, 44, 88, 91
Cableview	4, 30, 42, 44, 52, 63, 85, 88
Citizen	4, 30, 42, 44, 52, 63, 85, 88
Curtis	08, 09, 56, 61, 87, 90
Diamond	01, 29, 44, 88, 91
Drake	37
Eagle	13, 20, 22, 26, 40, 58, 62, 98
Eastern	28
GC Brand	4, 30, 42, 44, 52, 63, 85, 88
Gemini	04, 85
General Electric	57
General Instruments	01, 02, 03, 04, 34, 55, 83, 85, 91, 93, 95
Hamlin	14, 15, 28, 41, 97
Hitachi	31, 79
Jerrold	01, 02, 03, 04, 34, 55, 83, 85, 91, 93, 95
Macom	31, 79
Magnavox	25, 26
Matsushita	16, 17
Movietime	32, 38, 40
Movietime	29, 32, 39, 42, 44, 88
NSC	32, 38, 40
Oak	46
Panasonic	16, 17
Philips	13, 20, 23, 24, 96
Pioneer	05, 06, 78
Pulser	4, 30, 42, 44, 52, 63, 85, 88
RCA	16, 17
Realistic	44, 88
Regal	14, 41
Regency	28
Rembrandt	29, 32, 39, 42, 44, 88
Samsung	32, 40, 42, 78, 94
Scientific Atlanta	08, 09, 56, 61, 87, 90
Sheritech	27
SL Marx	32, 40, 42, 78, 94
Sprucer	16, 17
Stargate	32, 40, 42, 78, 94
Stargate	4, 30, 42, 44, 52, 63, 85, 88
Sylvania	19
Telecaption	77, 92
Televue	32, 40, 42, 78, 94
Texscan	18, 19
Tocom	01, 33, 34, 42, 48, 49, 91
Toshiba	36
Unika	01, 29, 44, 88, 91
Universal	42, 43, 44, 52, 63, 88
Viewstar	13, 20, 22, 26, 40, 58, 62, 98
Videoway	07, 23, 50
Zenith	07, 23, 50

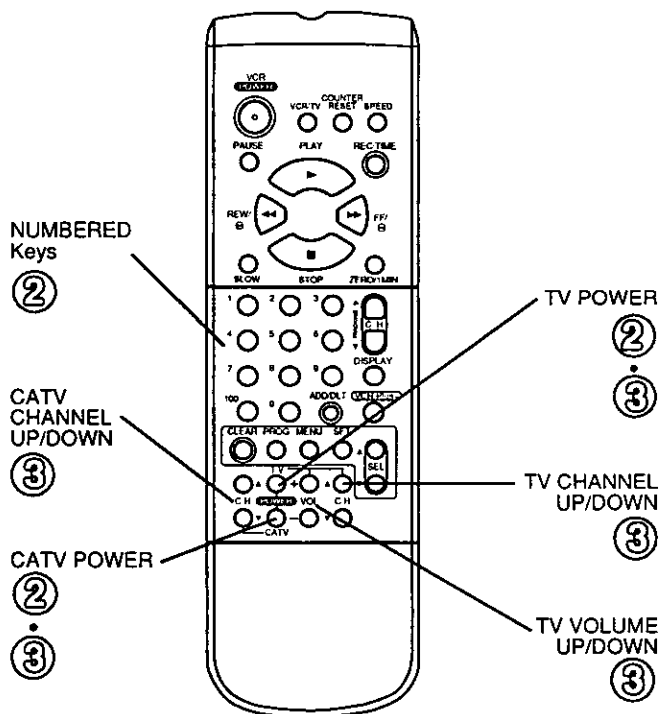

1 Find your TV or Cable Box Brand Code Numbers.

• See left chart for TV or Cable Box Brand Code Numbers.

2 Hold down TV POWER or CATV POWER and Use the NUMBERED keys to enter code number.

- Enter your TV or Cable Box brand code number.
- Due to changes in infra-red commands used by some manufacturers, some TV or Cable Box brands are listed more than once. If your TV or Cable Box does not respond in step 3 with the first code, please try entering the next code.

3 Try each of the following functions.

- Some TV and Cable Box brands require you to turn on the power manually.

(TV) POWER ON/OFF CHANNEL UP/DOWN VOLUME UP/DOWN	(Cable Box) POWER ON/OFF CHANNEL UP/DOWN
--	--

- Depending on your TV or Cable Box model, not all functions listed may be controlled by this remote.



- Please repeat the TV/ Cable Box Set Up procedure when you replace the remote's batteries.
- The remote control is designed to control the brands listed. However, it will not operate all TVs or Cable Boxes made by these manufacturers. If you get no results, your particular product brand cannot be controlled by this remote.



Before Requesting Service

Check the following points once again if you are having some trouble with your VCR.



Power	Correction
No power...	<ul style="list-style-type: none"> • Check that the Power Plug is completely inserted to an AC outlet. • Check that the POWER button is set to on.
Recording & Playback	Correction
TV program can't be recorded...	<ul style="list-style-type: none"> • Check the connections between the VCR, the external antenna, and your TV. • Check that the band selected matches your antenna or cable TV system. (P.11) • Make sure that the record tab on the back of the cassette is still intact. (P.5)
Timer recording can't be performed...	<ul style="list-style-type: none"> • Set the recording start/stop times correctly. (P.18) • Make sure that the POWER button is set to off. (P.18) • Timer recording may not be performed or continued if a power interruption of more than 1 minute occurs before, or during, Timer Recording, even if power resumes thereafter.
There is no playback picture, or the playback picture is noisy or contains streaks..	<ul style="list-style-type: none"> • Select the same channel on your TV as that of the Channel 3/4 switch located on the rear panel of the VCR. (P.6) • Set the VCR/TV selector to "VCR". (P.14) • Check that channel 3 or 4 of the TV is properly adjusted. • Adjust the TRACKING control slowly in either direction. (P.14)
During special effects playback, the picture may contain some vertical jitter when using a TV which has an Automatic Vertical Hold Control...	<ul style="list-style-type: none"> • Set the TV's Vertical Hold Control to "MANUAL" and then adjust it.
If the top of your playback picture waves back and forth excessively...	<ul style="list-style-type: none"> • Because the VCR playback signal is not as stable as an off-the-air TV signal, the top of your TV screen may be bent or unstable during playback. To solve this problem, slowly turn the horizontal hold control on your TV to correct the wavy picture. If your TV does not have a horizontal hold control or adjusting the control does not help, please contact your local TV service center.
VCR can't be controlled...	<ul style="list-style-type: none"> • Make sure that VCR LOCK is set to off. (P. 25)
Remote Control	Correction
VCR can't be remote controlled...	<ul style="list-style-type: none"> • Aim the Remote Control directly at the remote sensor on the VCR. (Refer to Back Cover.) • Avoid all obstacles which may interfere with the signal path. • Inspect or replace the batteries (P.4). • Make sure that VCR LOCK is set to off. (P. 25) • Exposing the VCR remote sensor to direct fluorescent or outdoor light may cause signal interference.
Miscellaneous	Correction
You can't view programs normally on TV...	<ul style="list-style-type: none"> • Set the VCR/TV selector to "TV". (P.17)
Video cassette can't be inserted...	<ul style="list-style-type: none"> • Insert the cassette with the window side up and the record tab facing you.
Video cassette can't be removed...	<ul style="list-style-type: none"> • Check that the power plug is completely connected to an AC outlet.
Video cassette ejects when the REC and PLAY buttons are pushed or when the POWER button is pushed off to set the Timer...	<ul style="list-style-type: none"> • Make sure the record tab on the back of the cassette is still intact. (P.5)
In the stop mode, the motor (CYLINDER) continues to rotate...	<ul style="list-style-type: none"> • To enable the quick play mechanism, the cylinder will rotate for about 5 minutes. • The quick play mechanism reduces response time from stop to PLAY mode from PLAY to REWIND search mode.
VCR can't be controlled...	<ul style="list-style-type: none"> • Make sure that VCR LOCK is set to off. (P. 25)

More You Can Do

Para fijar el idioma, canal y reloj

- 1**  Encienda el televisor y la videograbadora.

- 2** El televisor debe estar fijado al mismo canal que ha seleccionado en la parte trasera de la videograbadora (canal 3 o 4).

- 3**  Oprimir CH ▲ para elegir el idioma de la pantalla en inglés.
-  Oprimir CH ▼ para elegir el idioma de la pantalla en español.
-  Oprimir VCR/TV para elegir el idioma de la pantalla en francés.

SELECT LANGUAGE
 PUSH VCR CH ▲ : ENGLISH
 PULSE VCR CH ▼ : ESPAÑOL
 APP. VCR/TV : FRANÇAIS



Esta pantalla aparecerá en unos segundos.→

ESTA USANDO UNA CAJA DE TV POR CABLE O UN RECEPTOR DSS?
 PULSE MENU : SI
 PULSE PROG. : NO

- 4**  Oprimir MENU para elegir "SI" o PROG para "NO."
- Si ha elegido "SI", continúe al paso siguiente.
 - Si ha elegido "NO", pase al paso 8.

- 5**  Oprimir SEL ▲/▼ y SET para elegir la conexión de su equipo.
-  • Si es "CABLE/DSS-VCR-TV", continúe al siguiente paso. Si no es, pase al paso 8.

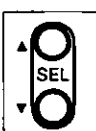
*FIJAR TV POR CABLE/DSS- ELEGIR LA CONEXION DE SU CAJA DE TV POR CABLE O RECEPTOR DSS
 CABLE/DSS-VCR-TV
 VCR-CABLE/DSS-TV
 ELEGIR : GIRE LA RUEDA
 FIJAR : PULSE LA RUEDA
 TERMINAR : PULSE MENU

- 6**  Oprimir SEL ▲/▼ y SET para fijar el canal de salida de la caja de TV por cable o el receptor DSS (el canal sintonizado en el televisor para ver la emisión de la caja de TV por cable o receptor DSS).
-  • Si ud. está usando los terminales de audio/video para la conexión de la caja de TV por cable, elija y fije a "SALIDA DE VIDEO" para el canal de salida.

*FIJAR TV POR CABLE/DSS- INTRODUCIR EL CANAL DE SALIDA DE SU CAJA DE TV POR CABLE O RECEPTOR DSS
 01
 ELEGIR : GIRE LA RUEDA
 FIJAR : PULSE LA RUEDA
 TERMINAR : PULSE MENU

- 7** Encienda la caja de TV por cable y fije la caja de TV por cable al canal PBS de su zona.

- 8**  Oprimir CH ▲ para iniciar la fijación automática de los canales.

FIJACION AUTO. (CA/RELOJ)
 CONECTE EL CABLE DE LA ANTENA Y SI ESTA USANDO UNA CAJA DE TV POR CABLE SINTONICE AL CANAL PBS DE SU LOCAL LUEGO...
 POR FAVOR OPRIMIR CH UP

- Las siguientes informaciones aparecerán seguidamente: "AUTOPROGRAMACION EN PROCESO" "AUTOPROGRAMACION COMPLETO" "FIJACION AUTOMATICA DEL RELOJ EN PROCESO"

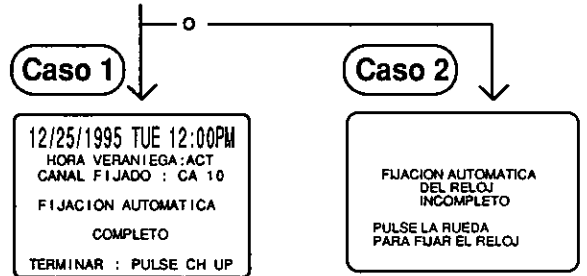

- 9** **Caso 1** Comprobar si la hora está fijada correctamente y luego oprimir CH ▲ para terminar la fijación.

Si la hora y la hora veraniega es incorrecta, por favor siga los siguientes pasos:

Raras veces, en caso de que ud. vive cerca de dos zonas con hora diferente, el aparato puede elegir un canal PBS con diferente hora de su zona. En este caso, haga los siguientes pasos:

- 1 Tome nota del canal que está fijado en la pantalla y salga desde este modo oprimiendo el botón CH ▲.
- 2 Anule este canal desde los canales memorizados en la combinación de VCR/TV.
- 3 Oprima el botón MENU para que aparezca la pantalla del MENU.
- 4 Use la rueda para elegir "FIJAR RELOJ" y luego para elegir "AUTO MÁTICO."
- Si ud. esta usando una caja de TV por cable y tiene muchos canales PBS, sintonice la caja de TV por cable a un canal PBS diferente e intente la fijación automática otravez.

- Caso 2** Si aparece la pantalla anterior, la fijación automática del reloj no es disponible en su zona. Por favor fije la hora del reloj manualmente.

Fijación manual del reloj

- 1 Oprimir MENU para que aparezca la pantalla de la fijación del reloj.
- 2 Girar y oprimir la RUEDA para elegir y fijar el mes, la fecha, el año, la hora y la hora veraniega.

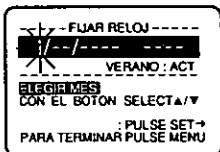

Para hacer correcciones

Oprimir la rueda o el botón CLEAR repetidamente para retroceder o avanzar hasta el paso que desea corregir.

- 3 Oprimir MENU dos veces para iniciar a funcionar el reloj y salir desde este modo.

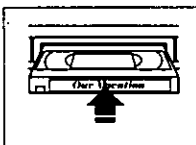

Operaciones básicas para la reproducción

- 1  Introducir una cinta
 - La videograbadora se enciende automáticamente.

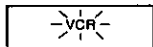

Esta indicación aparece en la pantalla multifuncional.

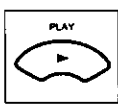
- 2  Oprimir PLAY para comenzar a reproducir.
 - Si la cinta no tiene la lengüeta para evitar borrado la videograbadora comienza a reproducir automáticamente. (Videograbadora o Control Remoto)

- 3  Oprimir REW o FF para localizar rápidamente una escena.

(Videograbadora o Control Remoto)

 - La velocidad de búsqueda en el modo SP es a 9 veces más rápida que la velocidad normal y en el modo SLP es a 27 veces más rápida.
 - Durante la búsqueda aparece alguna barras de ruido.

- 4  Oprimir STOP para parar la reproducción.

(Videograbadora o Control Remoto)

- 5  Oprimir STOP/EJECT para expulsar la cinta.
 - Este botón se encuentra solamente en la videograbadora.

Operaciones básicas para la grabación

- 1  Introducir una cinta con la lengüeta.

- La videograbadora se enciende automáticamente.

- 2  Oprimir CH ▲/▼ para elegir el canal.

- U oprimir CHANNEL ▲/▼ en la videograbadora.
- Para grabar desde una fuente externa, oprimir CH ▲/▼ para elegir "LINEA".

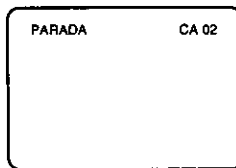

- 3  Oprimir SPEED para cambiar la velocidad de la cinta.

- SP = Reproducción estándar, LP = Larga duración, SLP = Supertarga duración.

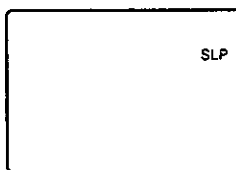

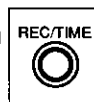
- 4  Oprimir REC/TIME con el control remoto para empezar a grabar.
 - U oprimir PLAY y REC/TIME en la videograbadora.

Grabación de un toque (OTR)

La videograbadora termina la grabación a una hora programada.

Oprima sucesivamente REC/TIME para fijar el tiempo de la grabación. Cada presión cambiará la hora de parada como demuestra al siguiente.

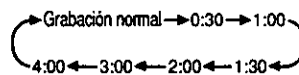

- La indicación TIMER aparece en la pantalla multifuncional.

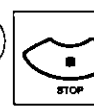
- 5  Oprimir STOP para parar la grabación.
 - U oprimir STOP en la videograbadora.

- Si mantiene oprimiendo el botón de CH ▲/▼ aumentará la velocidad del cambio del canal.
- Oprimir PAUSE para hacer una pausa en la grabación en progreso.

Programación fácil para la grabación con temporizador

1  Oprimir PROG para que aparezca la pantalla de la programación.

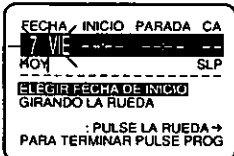

- Si ya existe una programación, elija usando la rueda un número sin programación.

5  Oprimir PROG para salir desde este modo.

6  Oprimir POWER y apague el aparato para la grabación con temporizador.

Pantalla multifuncional



- Si la fuente de la grabación es una caja de TV por cable, asegúrese de que la caja de TV por cable esté encendido y esté sintonizado al canal que desea grabar.

2  Oprimir SEL ▲/▼ y SET para elegir y fijar la fecha.

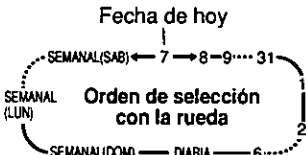

Grabación diaria y semanal

Si ud. desea programar una grabación diaria (lunes a viernes), elija DIARIO en vez de la fecha en el paso 2. Si desea una grabación semanal, elija SEMANAL LUN, MAR, etc.

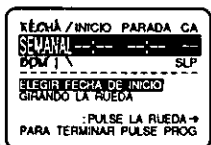
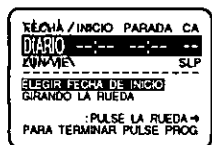

3  Oprimir SEL ▲/▼ y SET para elegir y fijar las fijaciones que sobran.

Fijaciones:

- Hora de inicio
- Hora de parada
- Canal o LINEA para una fuente externa.
- Velocidad de la cinta (SP, LP, SLP).

Para hacer correcciones

Oprimir la rueda sucesivamente para avanzar u oprimir CLEAR para retroceder hasta el paso que desea corregir.

4  Oprimir PROG para terminar la programación.

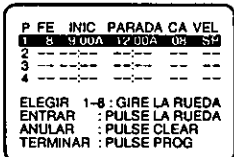

- Si desea hacer más programaciones, elija un número de programa en blanco con la rueda y repita los paso 2 y 3.

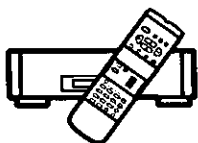

Index of Controls

Multi Function Display

VCR Indicator

Appears when the VCR/TV selector is set to VCR.

Power Indicator

This indicator lights when power is turned on.

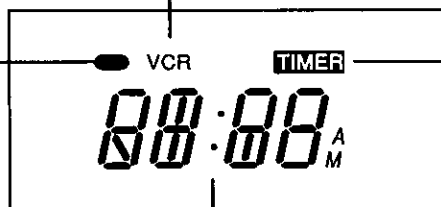

Timer Indicator

This indicator lights when the VCR is set for a Timer Recording, or if a length is set for normal recording. It flashes when a Timer Recording has been set, but a tape has not been inserted into the VCR.

Clock/Status/Channel Display

Displays the current time.

Briefly displays VCR status when function button is pressed.

Also, briefly displays the channel number selected or "L" when channel button is pressed or select a line input.

Rear View of the VCR

AC Power Plug

When plugged into an AC outlet, the VCR consumes 6W of electric power in OFF condition.

Audio Input Connector

See pages 21, 22.

Video Input Connector

See pages 21, 22.

VHF/UHF Antenna Input Terminal

See pages 6~9, 22.

VHF/UHF Antenna Output Terminal

See pages 6~9.

Video Output Connector

See page 21.

Channel 3/4 Switch

See pages 6, 10.

Audio Output Connector

See page 21.

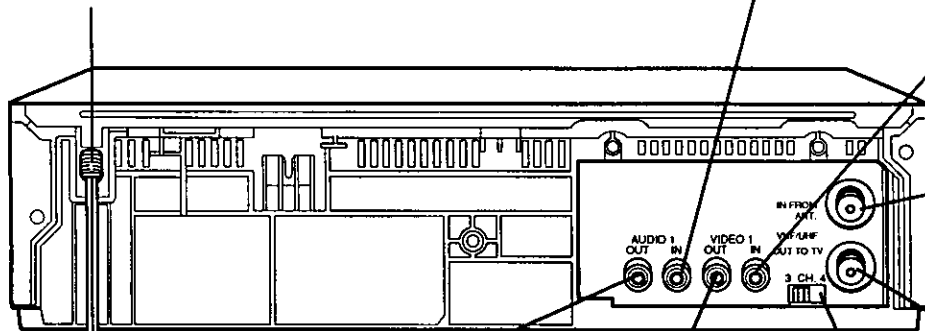

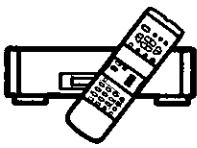

Index of Controls

Remote Control Button

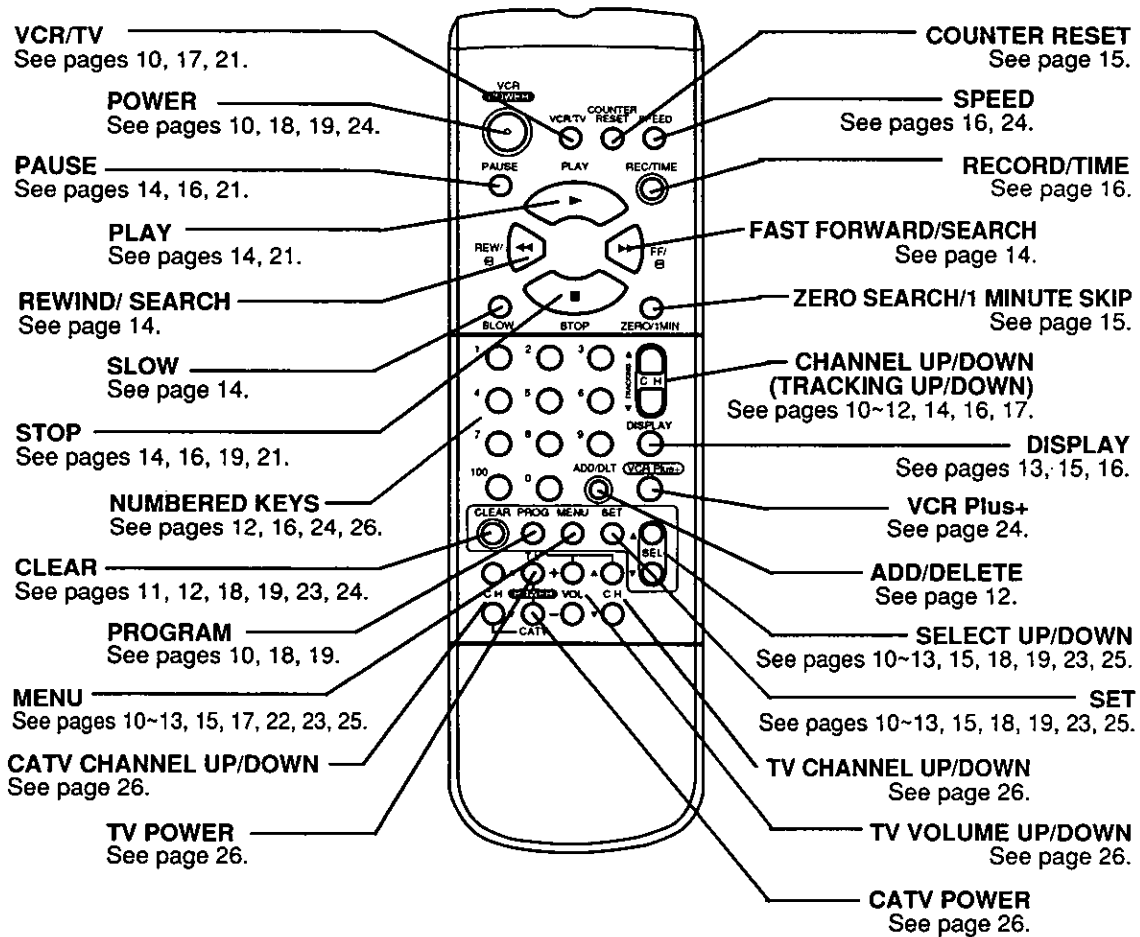

Front View of the VCR

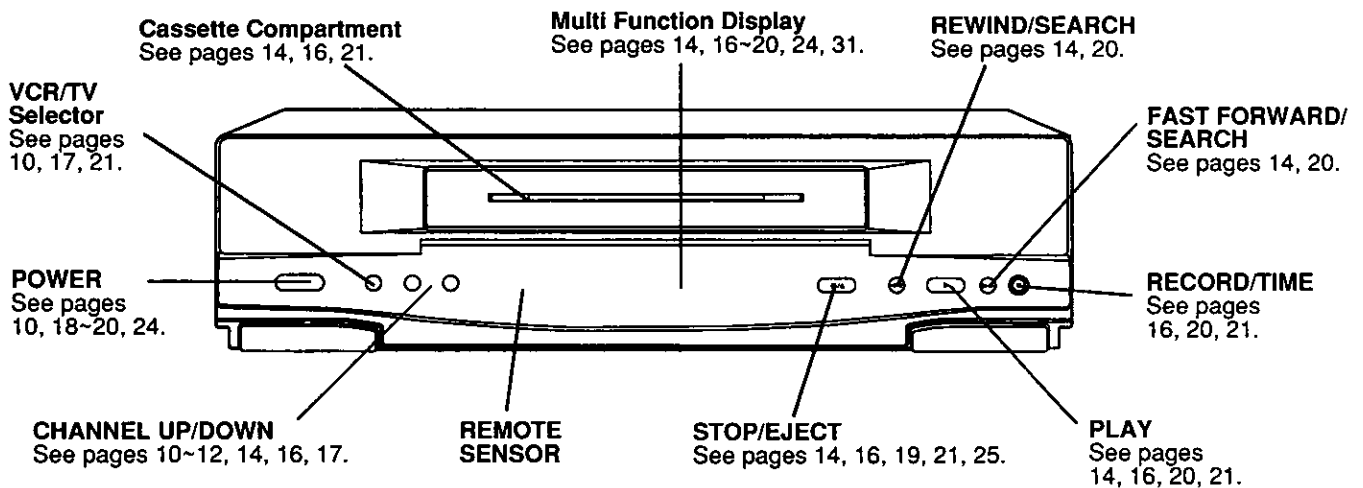

Matsushita Consumer Electronics Company, Division of Matsushita Electric Corporation of America
One Panasonic Way Secaucus, New Jersey 07094

Panasonic Sales Company, Division of Matsushita Electric of Puerto Rico, Inc. ("PSC")
Ave. 65 de Infanteria. Km. 9.5
San Gabriel Industrial Park, Carolina, Puerto Rico 00985

